

# PENDELBAHNSTÜTZE

Diese Skizze soll dir eine kleine Hilfe beim zusammenbauen der ModellRopeways Pendelbahnstütze sein.  
Die Nummern in der Skizze entsprechen den Nummern der jeweiligen Bogenteile.

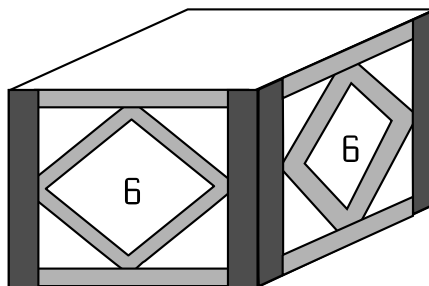

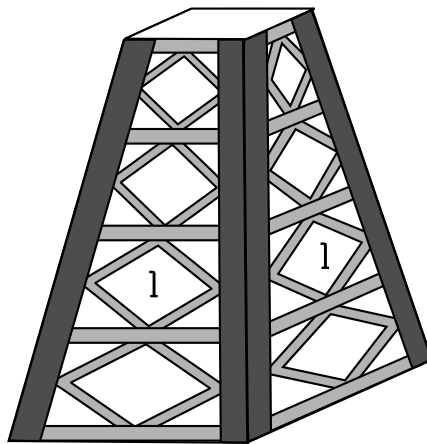

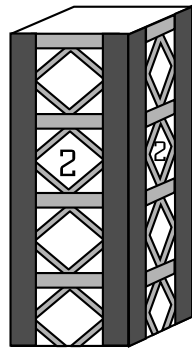
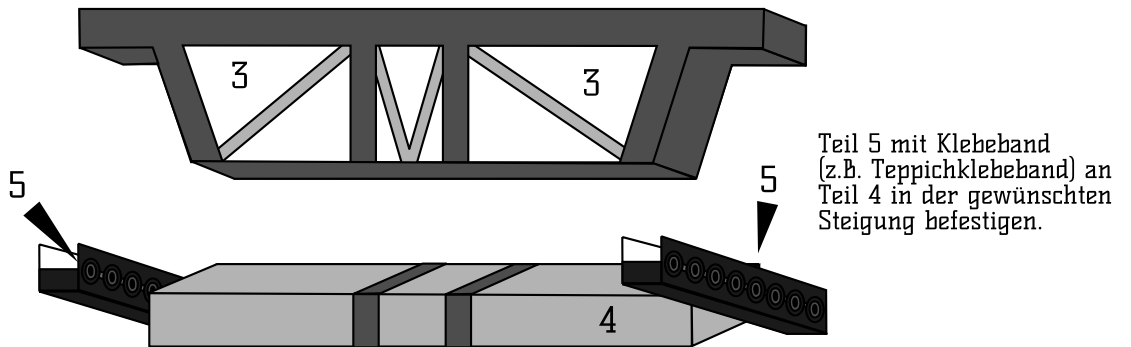
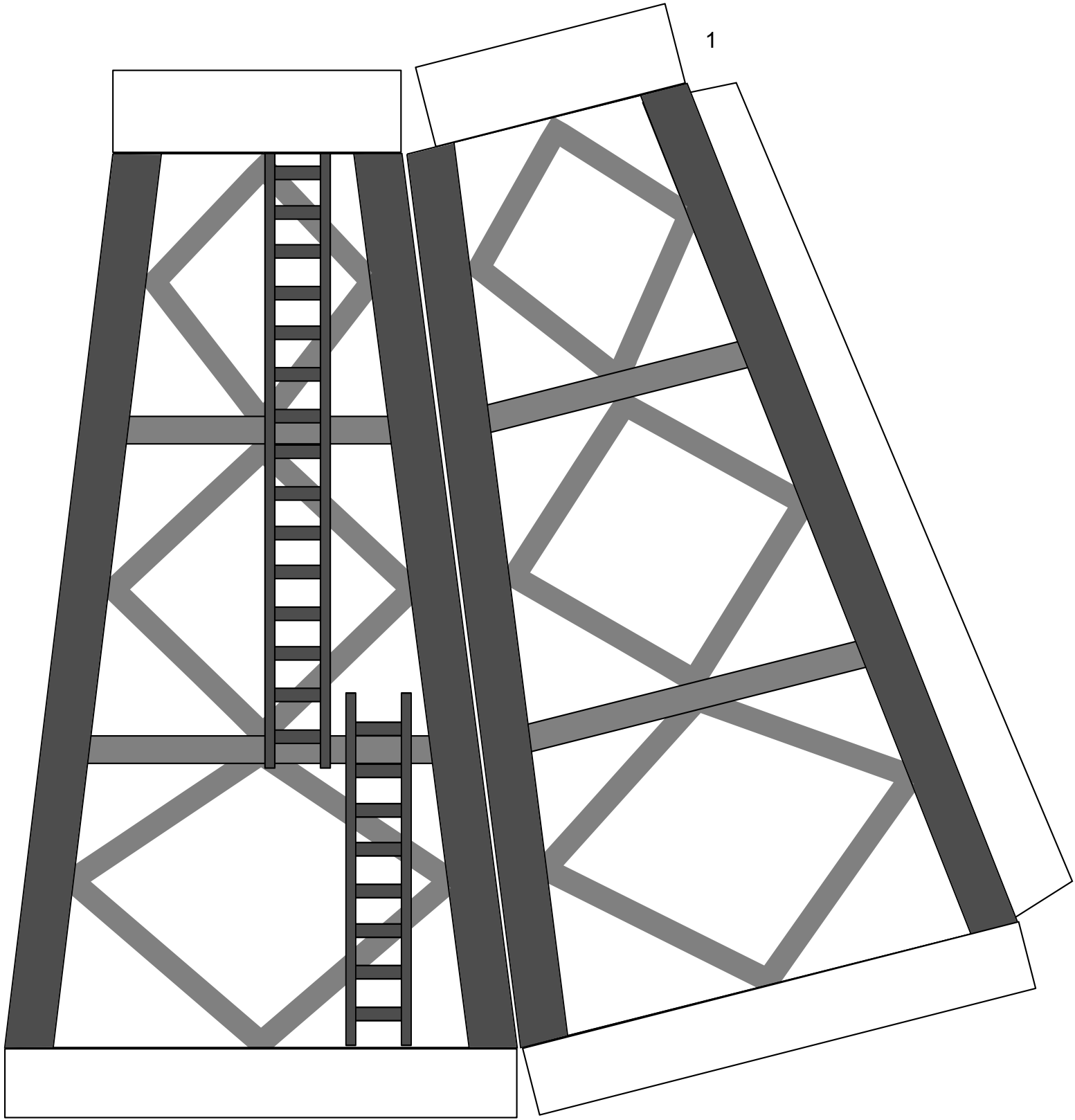
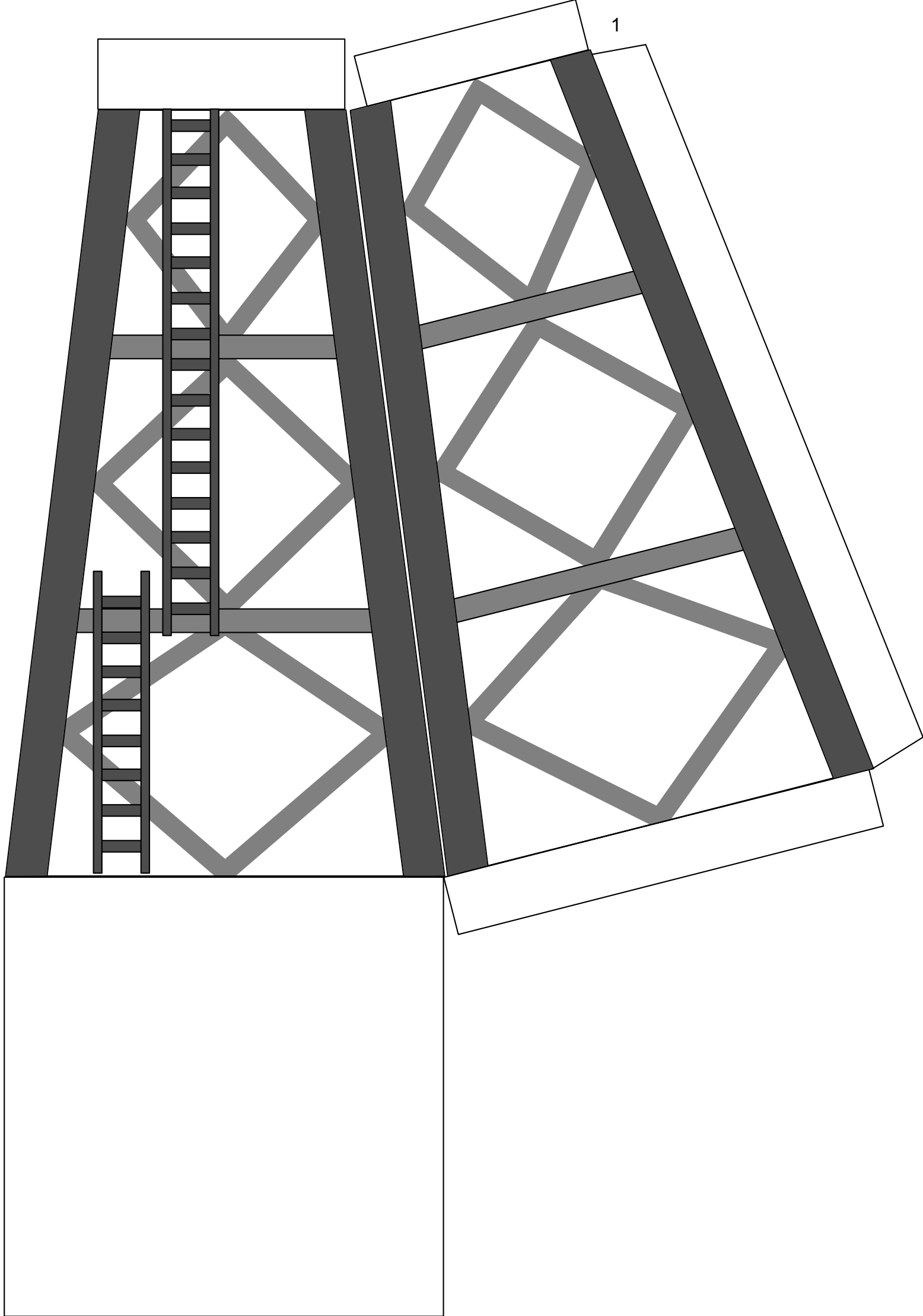

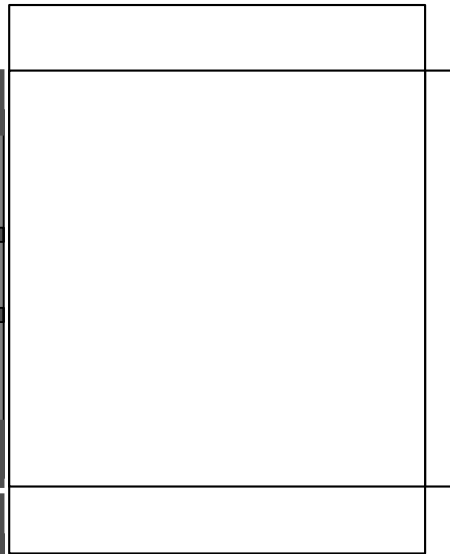
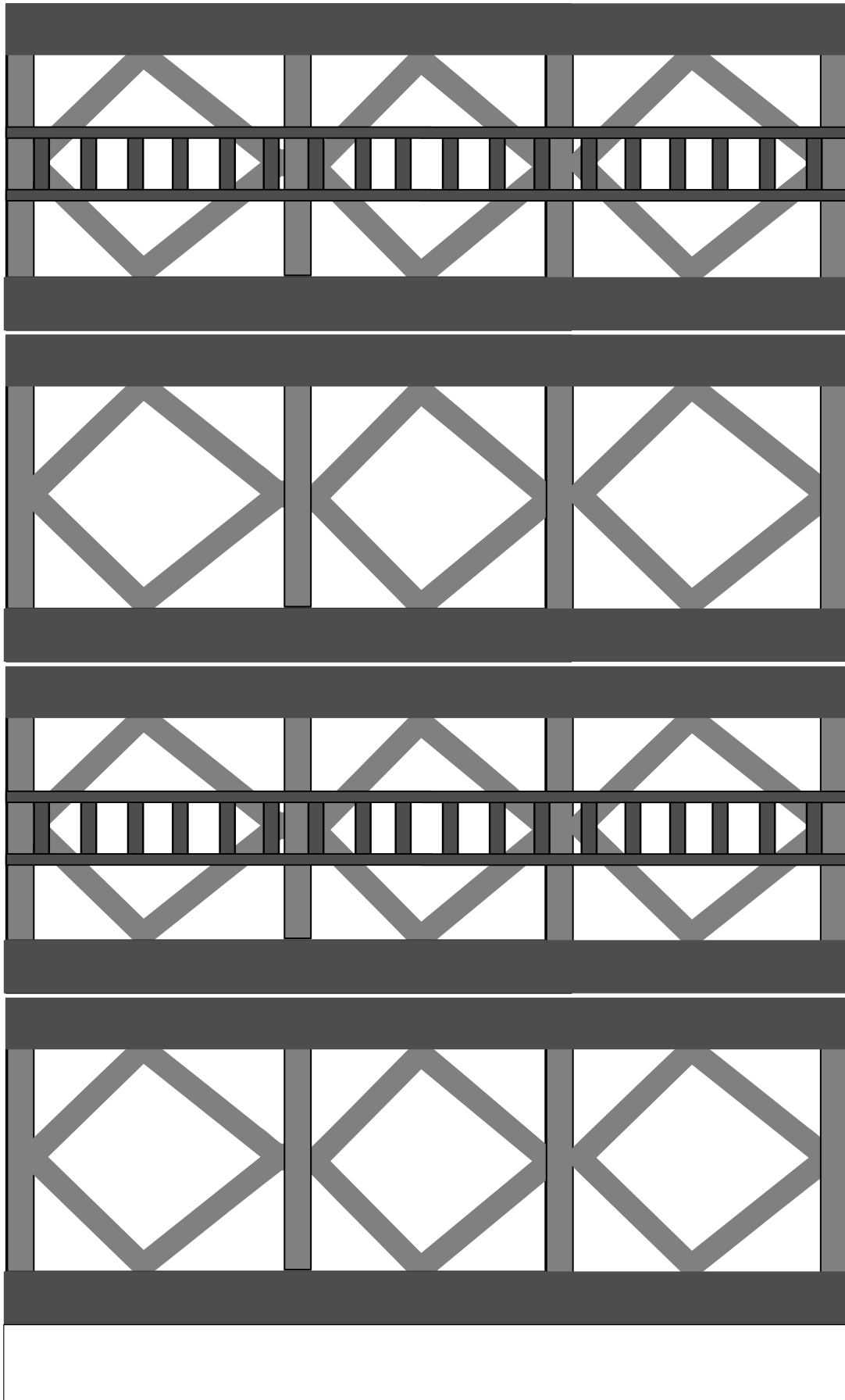

2

3

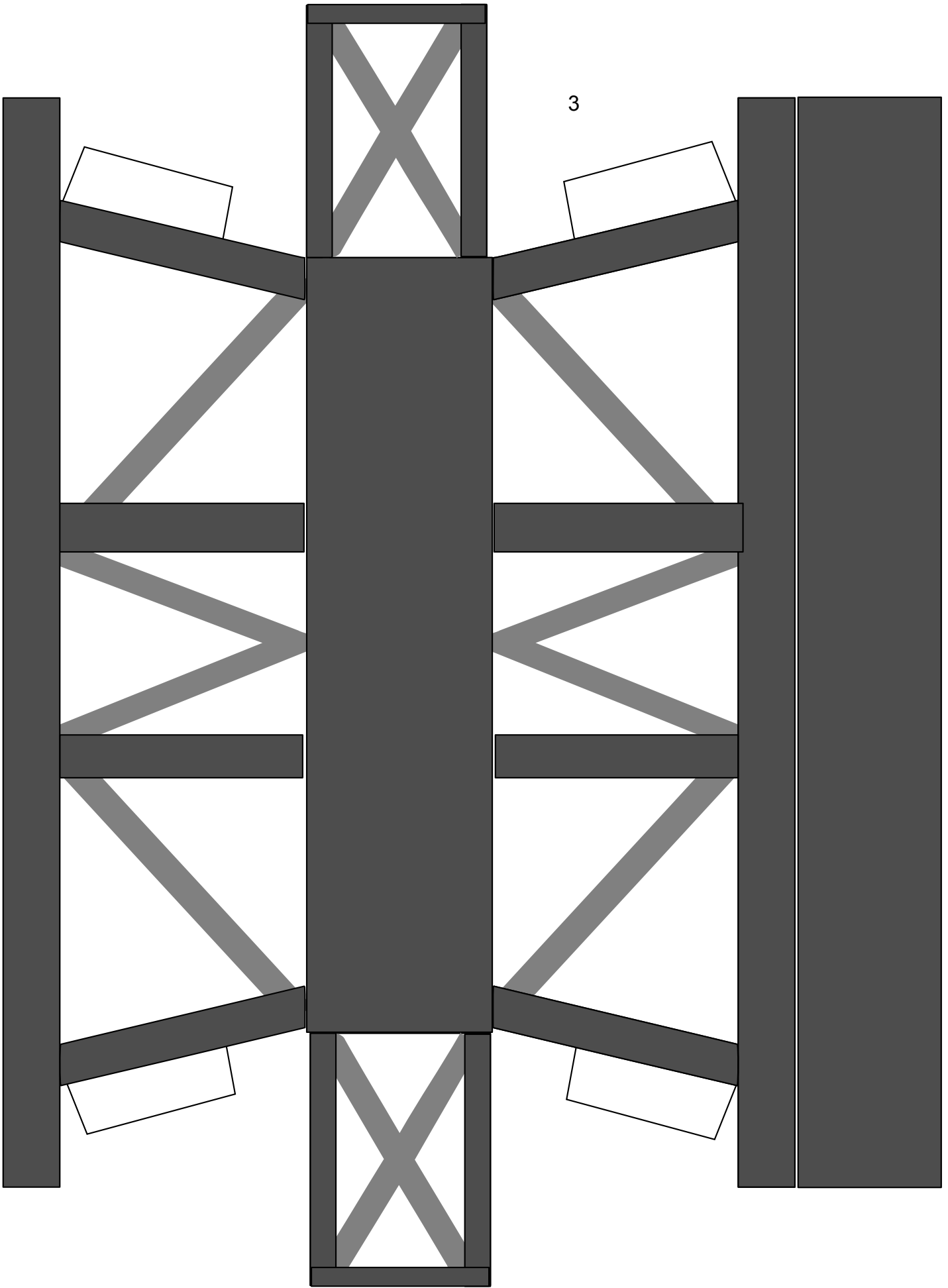

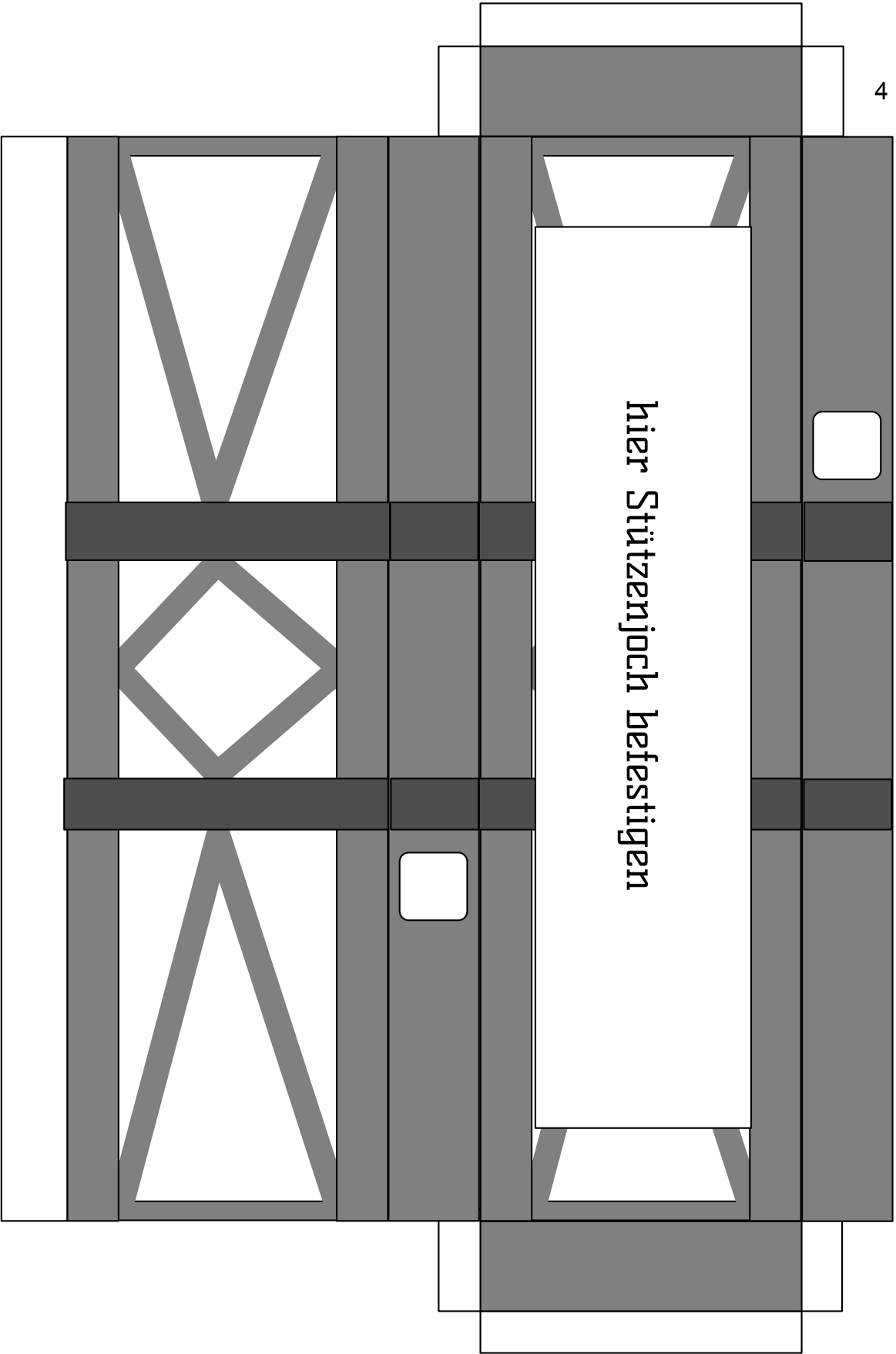

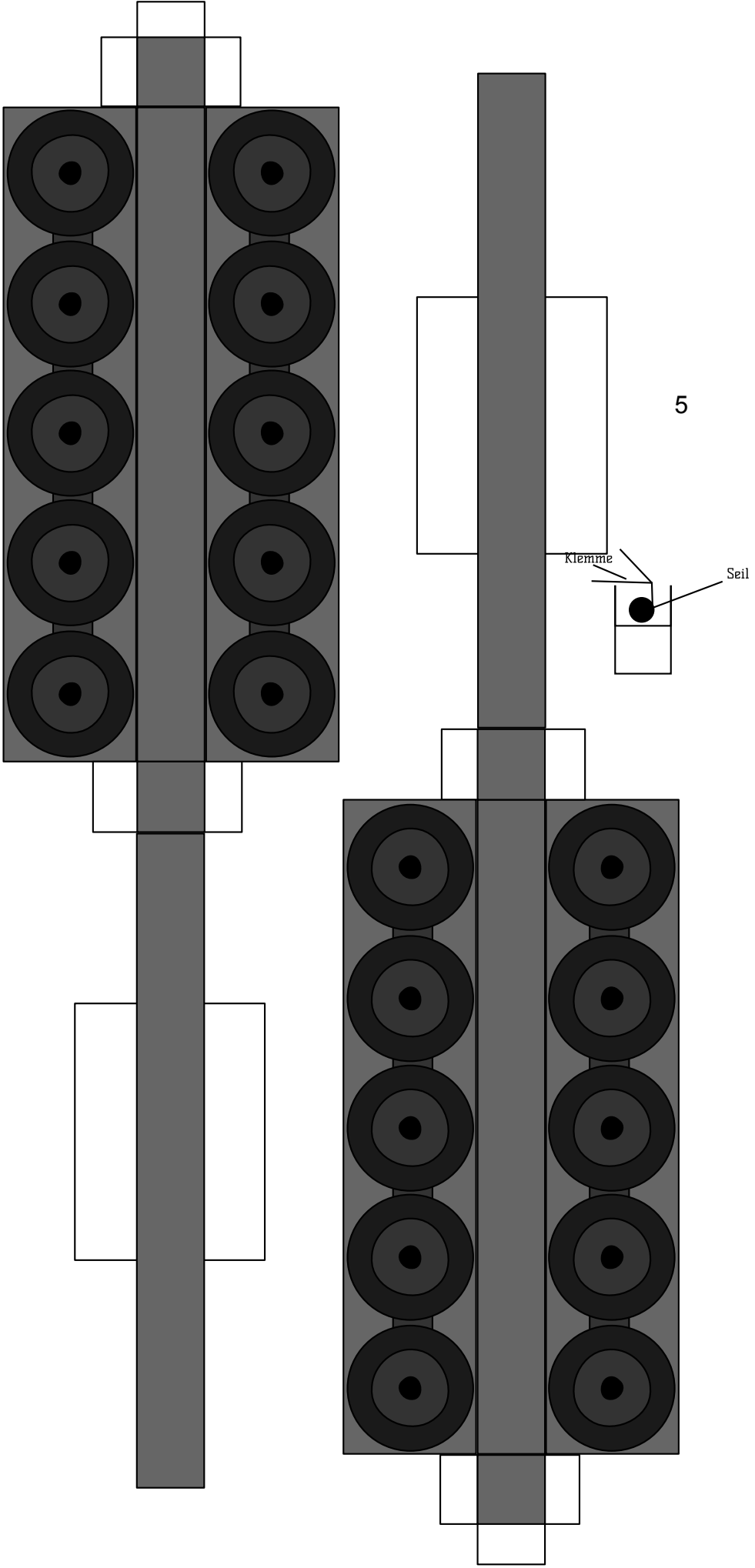

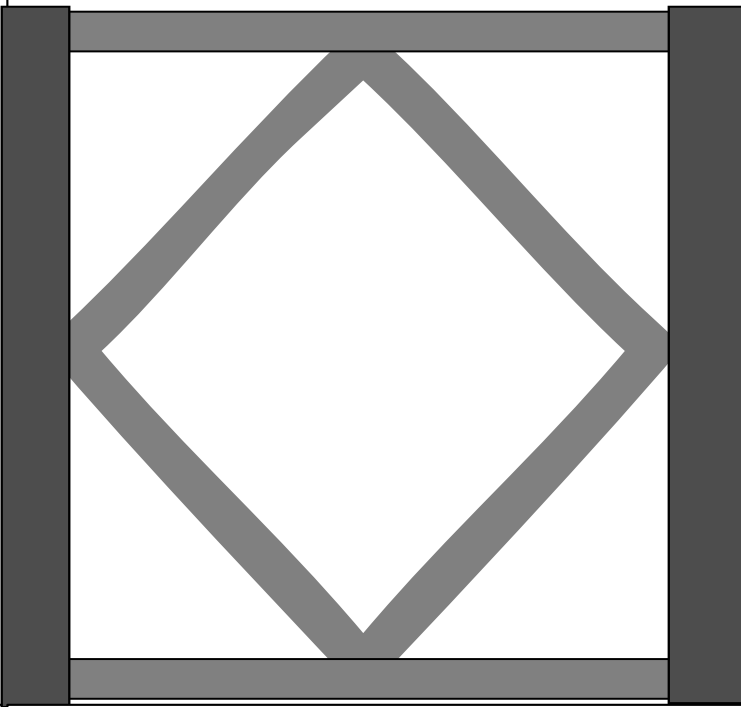

hier Teil A ankleben

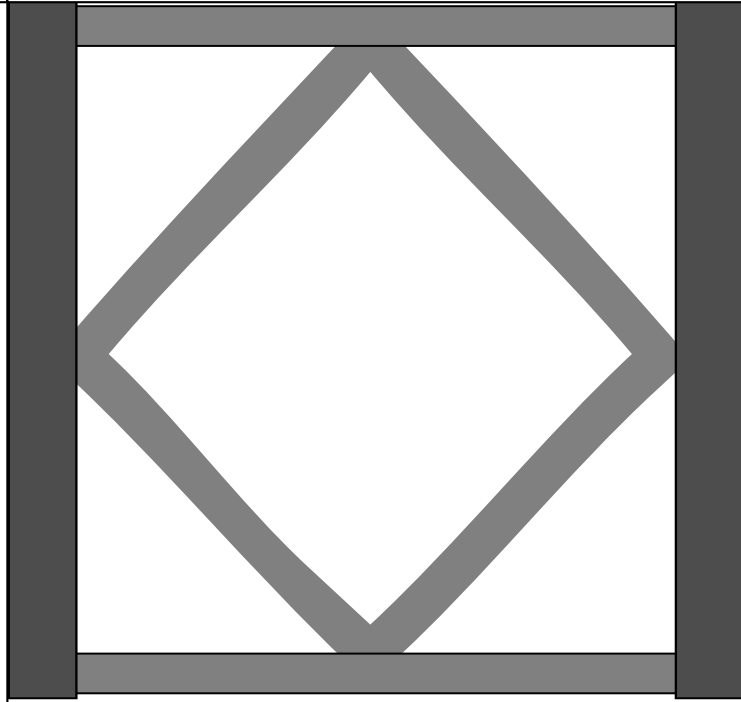
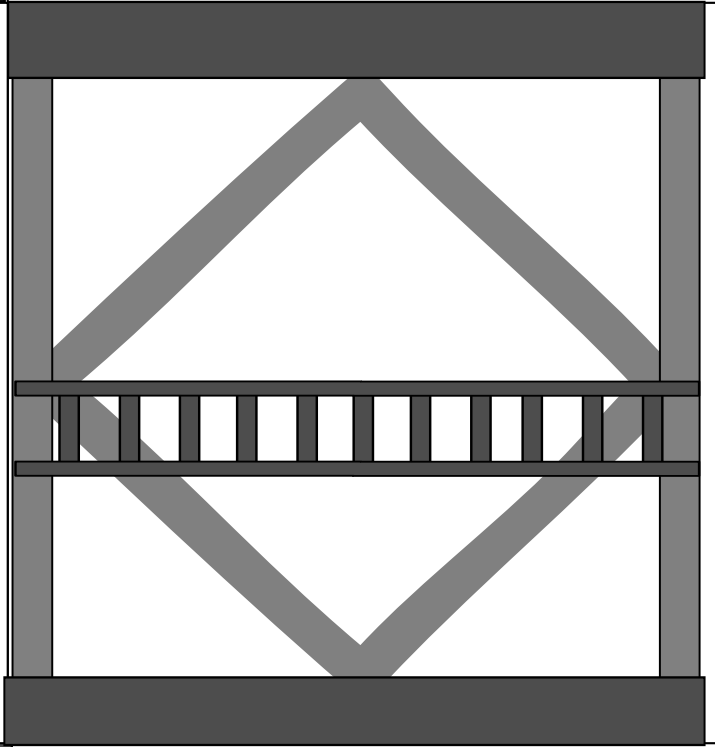



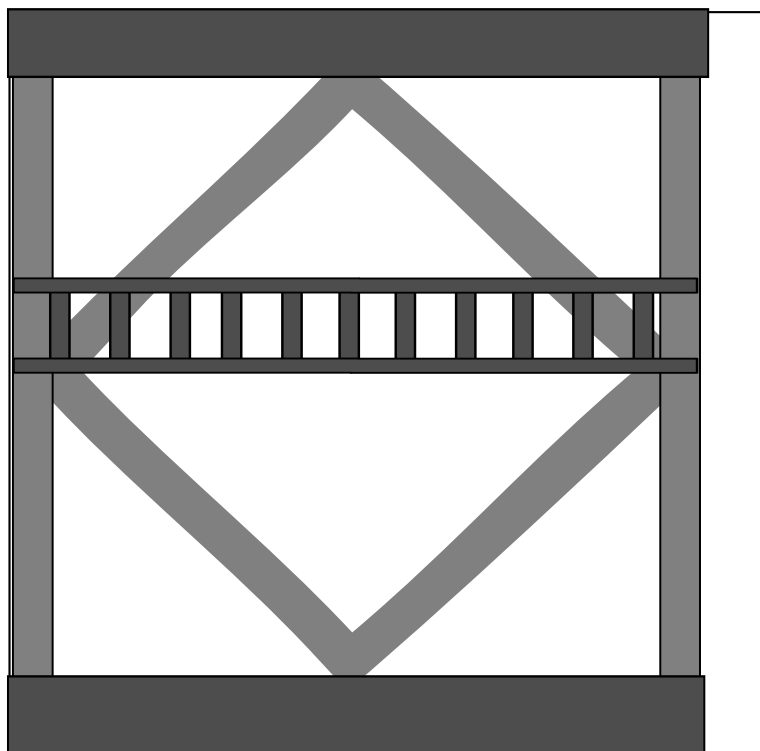

6 A