

TECHNO ALPIN PIANO

Diese Skizze soll dir eine kleine Hilfe beim zusammenbauen der ModellRopeways Techno Alpin Piano sein.
Die Nummern in der Skizze entsprechen den Nummern der jeweiligen Bogenteile.

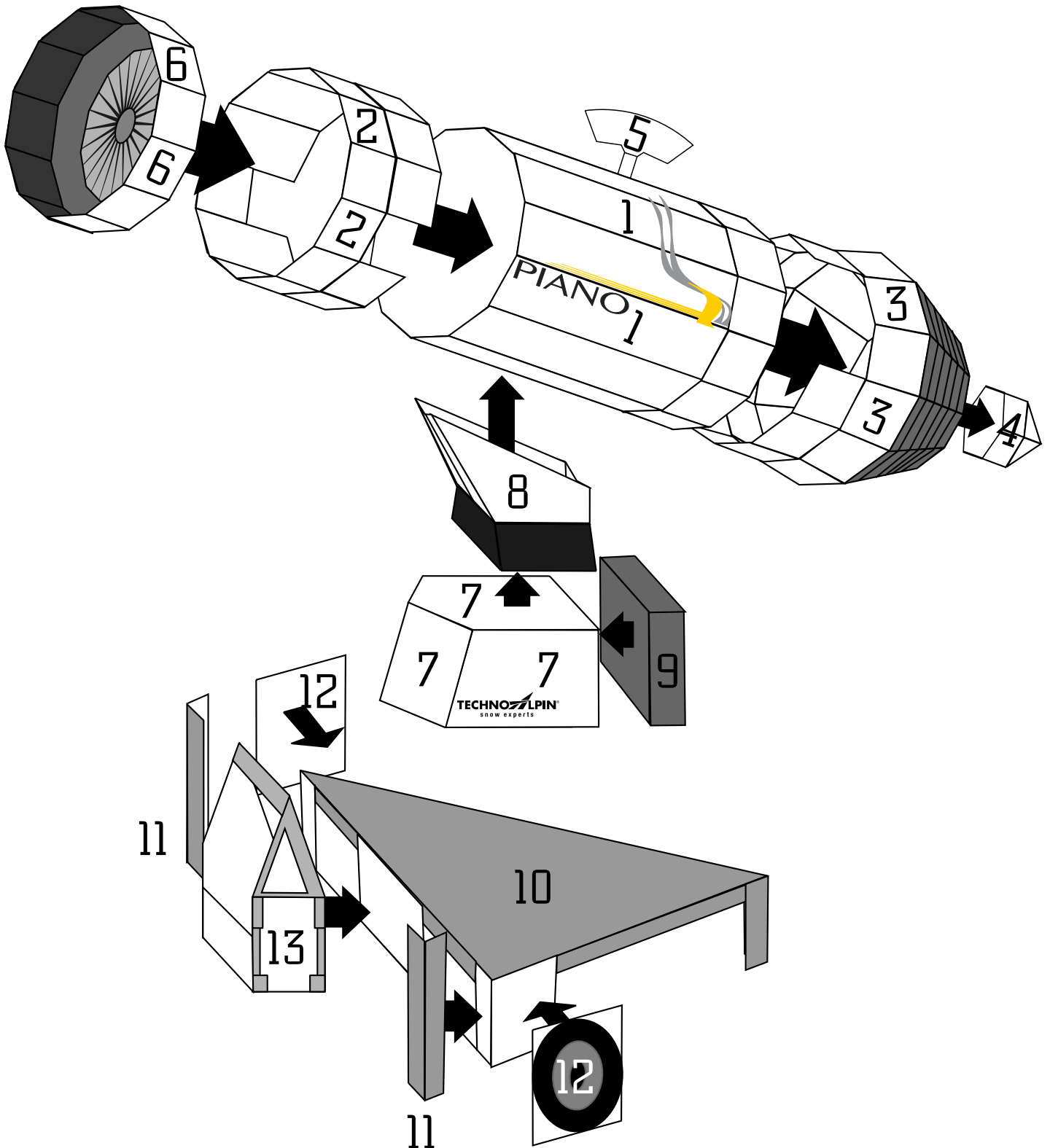

1

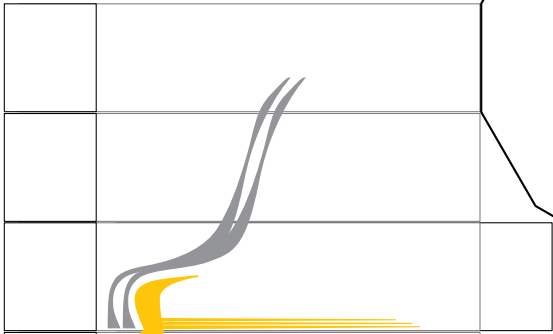
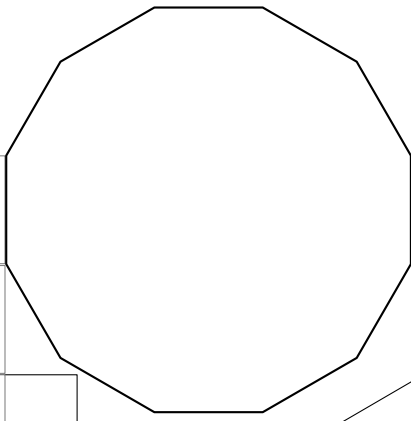

PIANO



PIANO

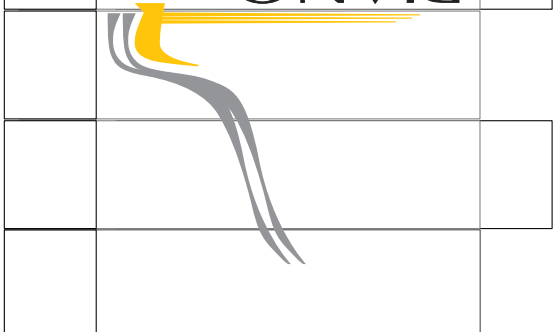

3

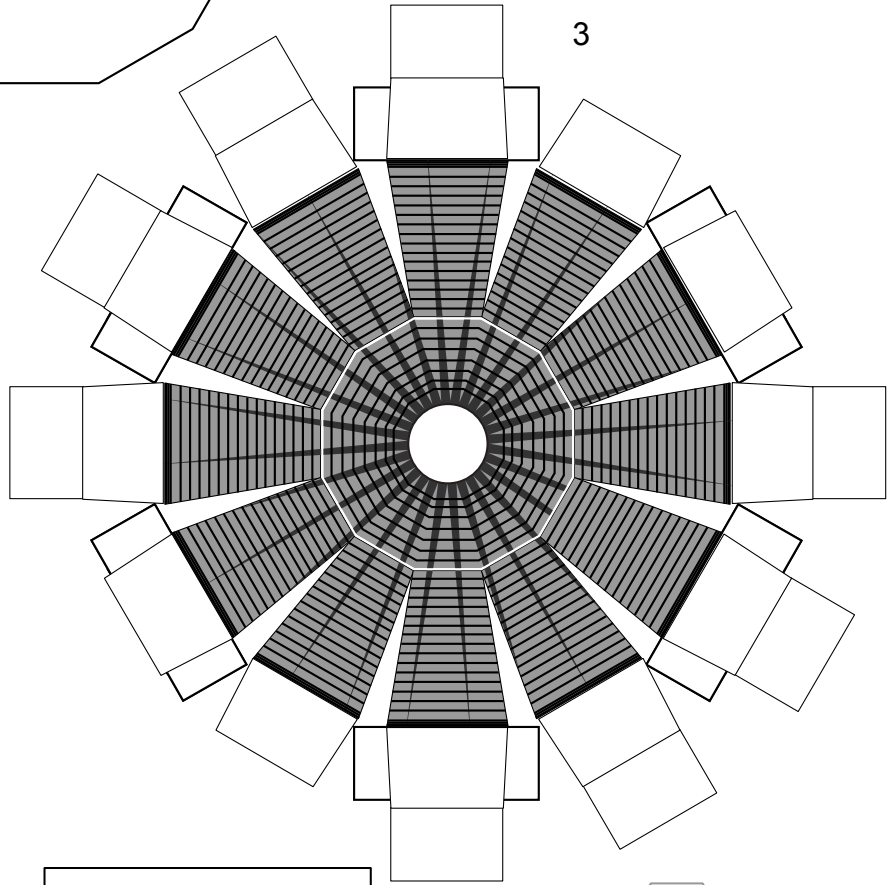

9

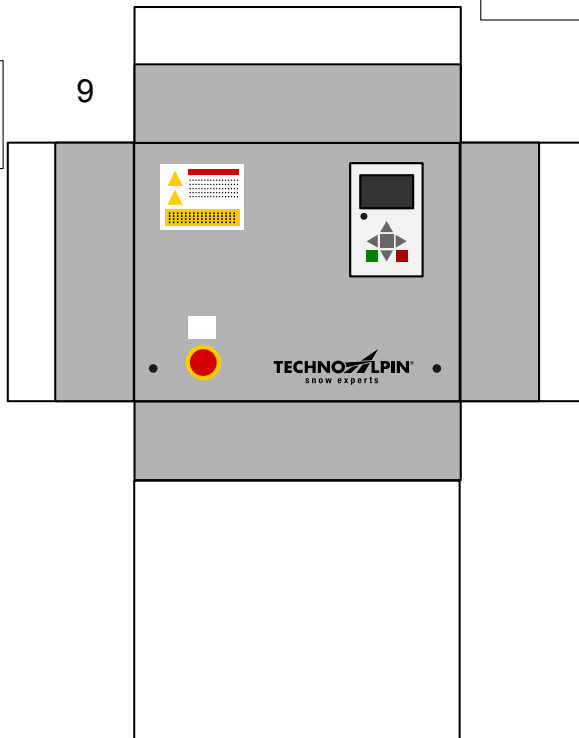

4

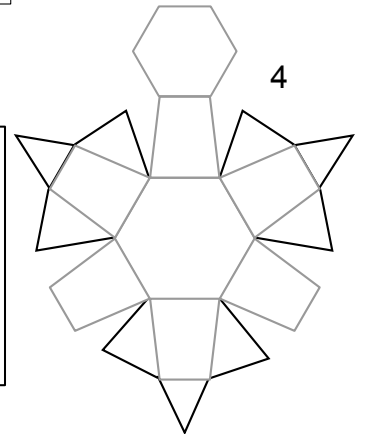

5

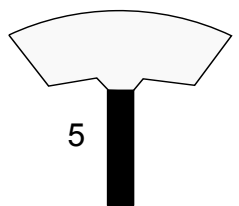

2

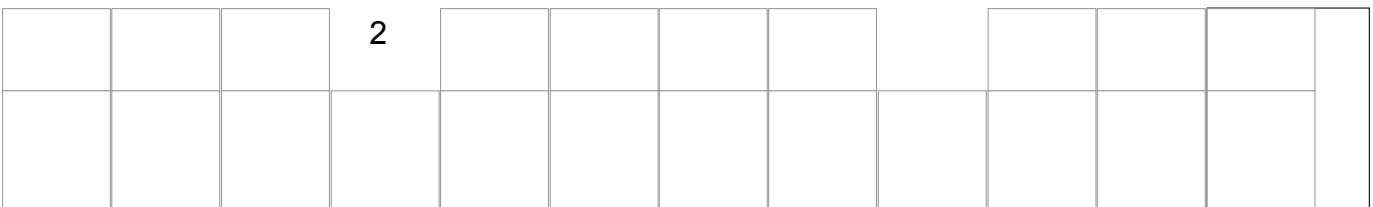

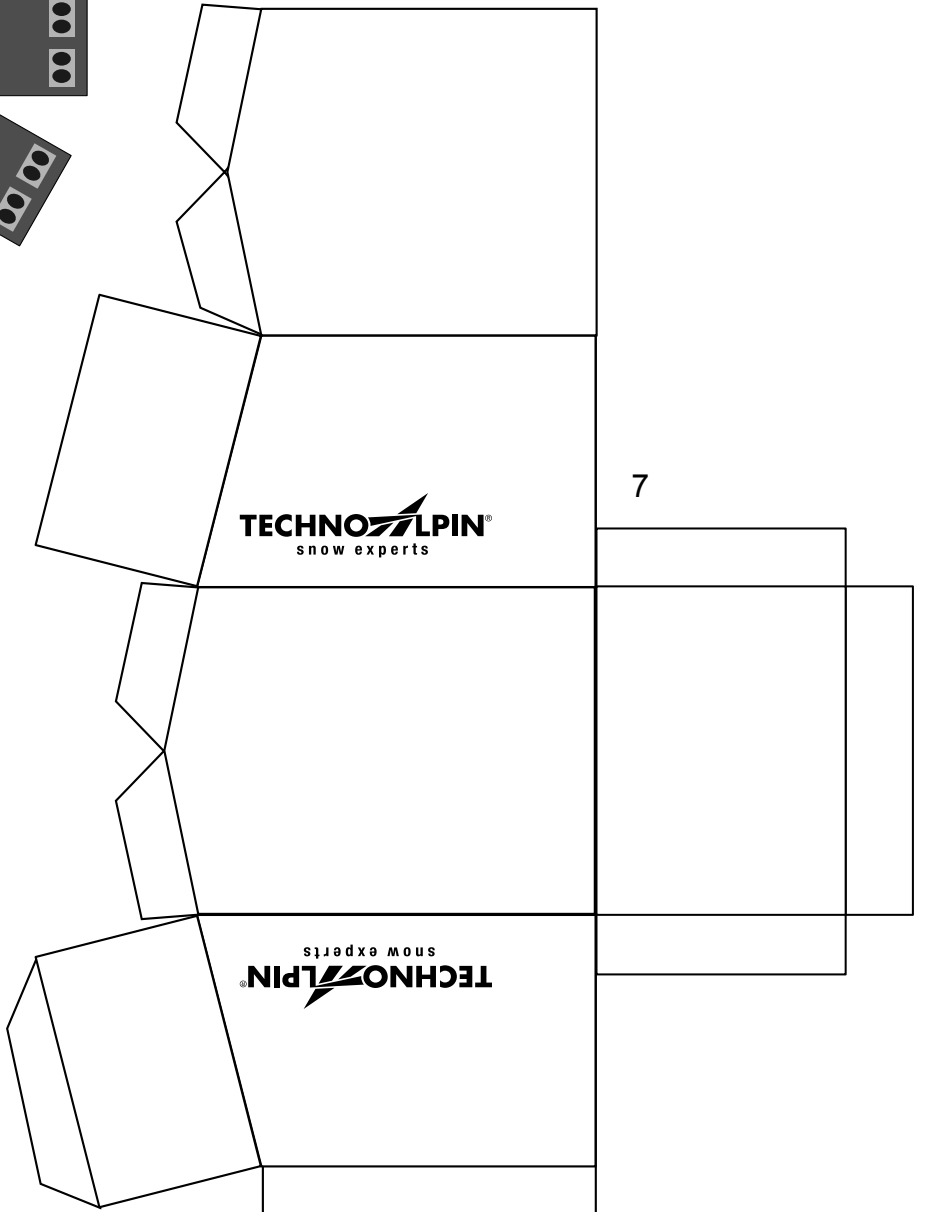
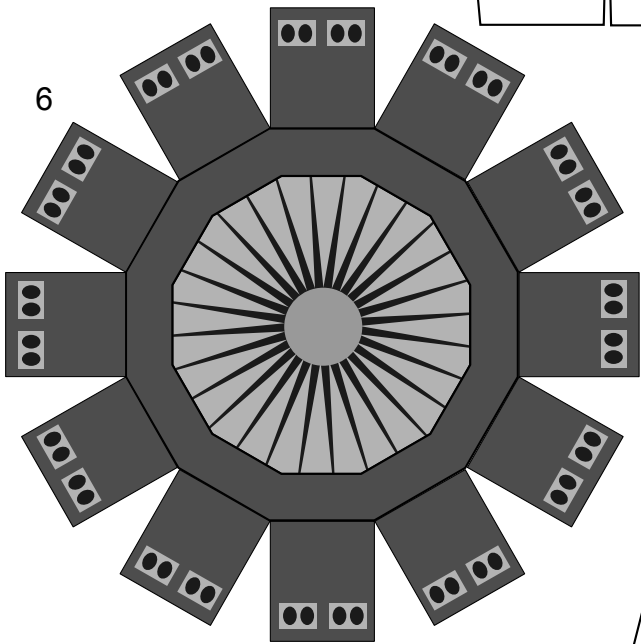
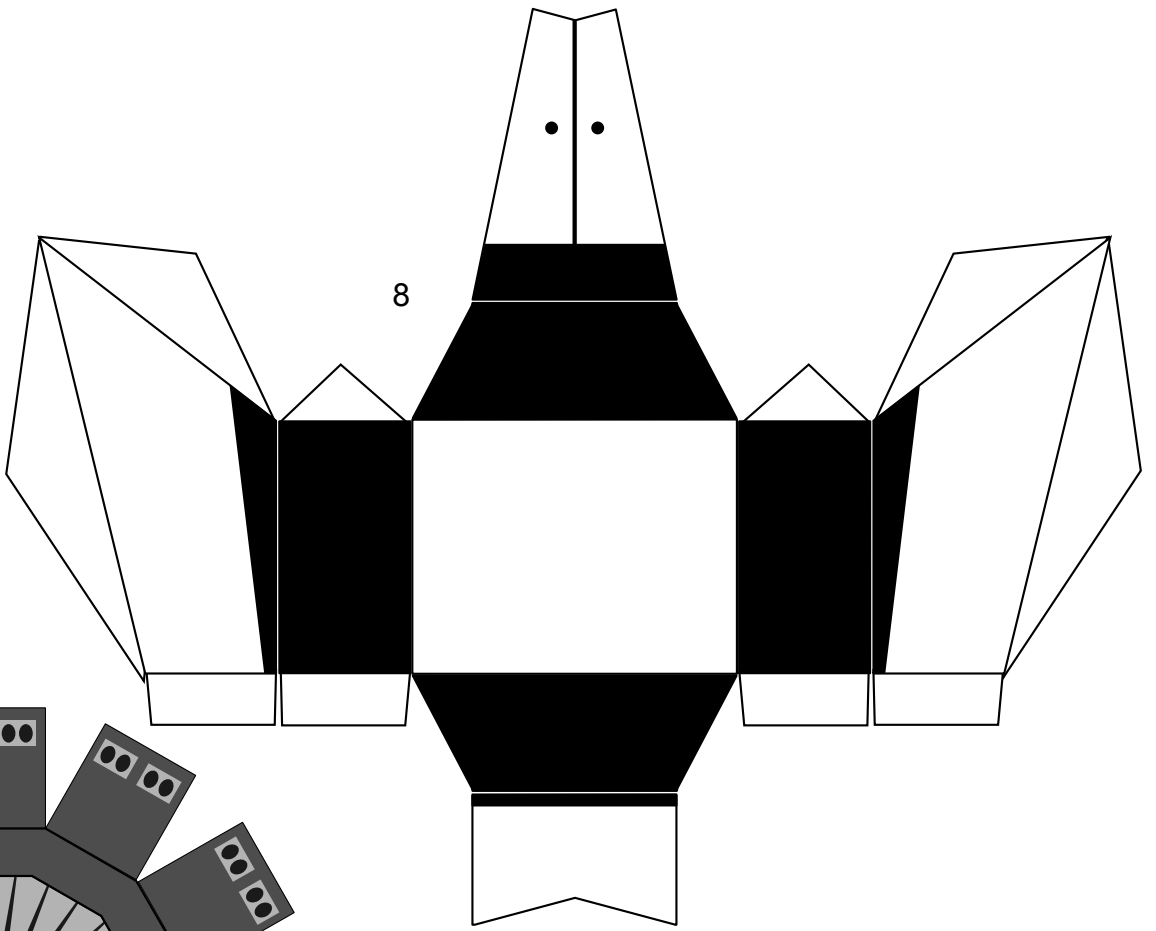

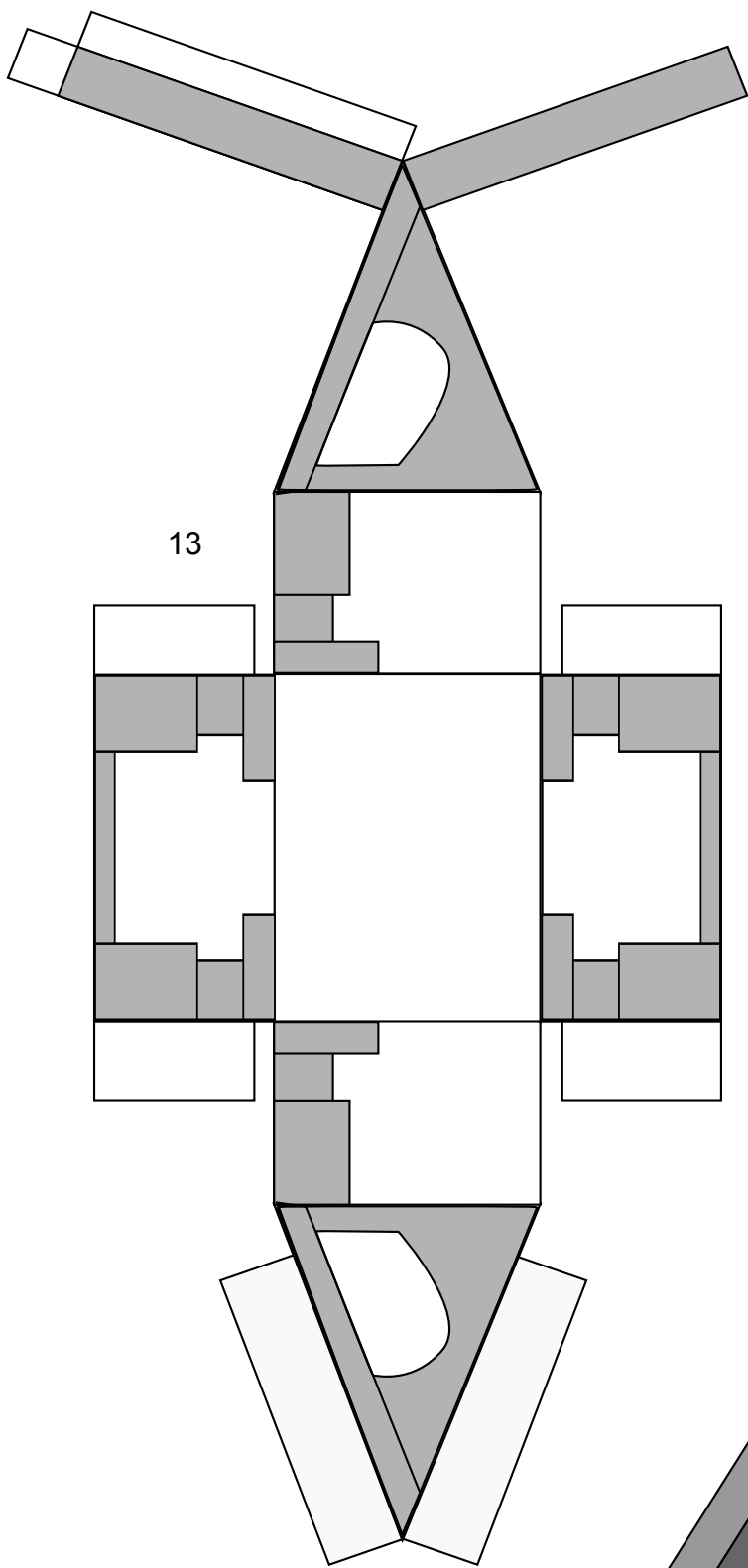

13

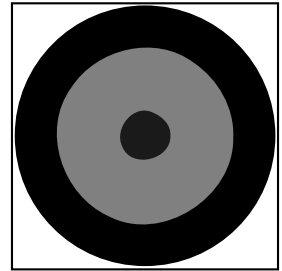

12

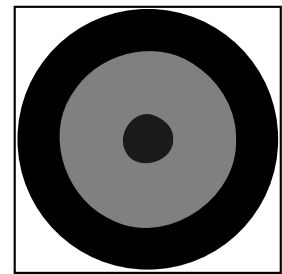

12

11

11

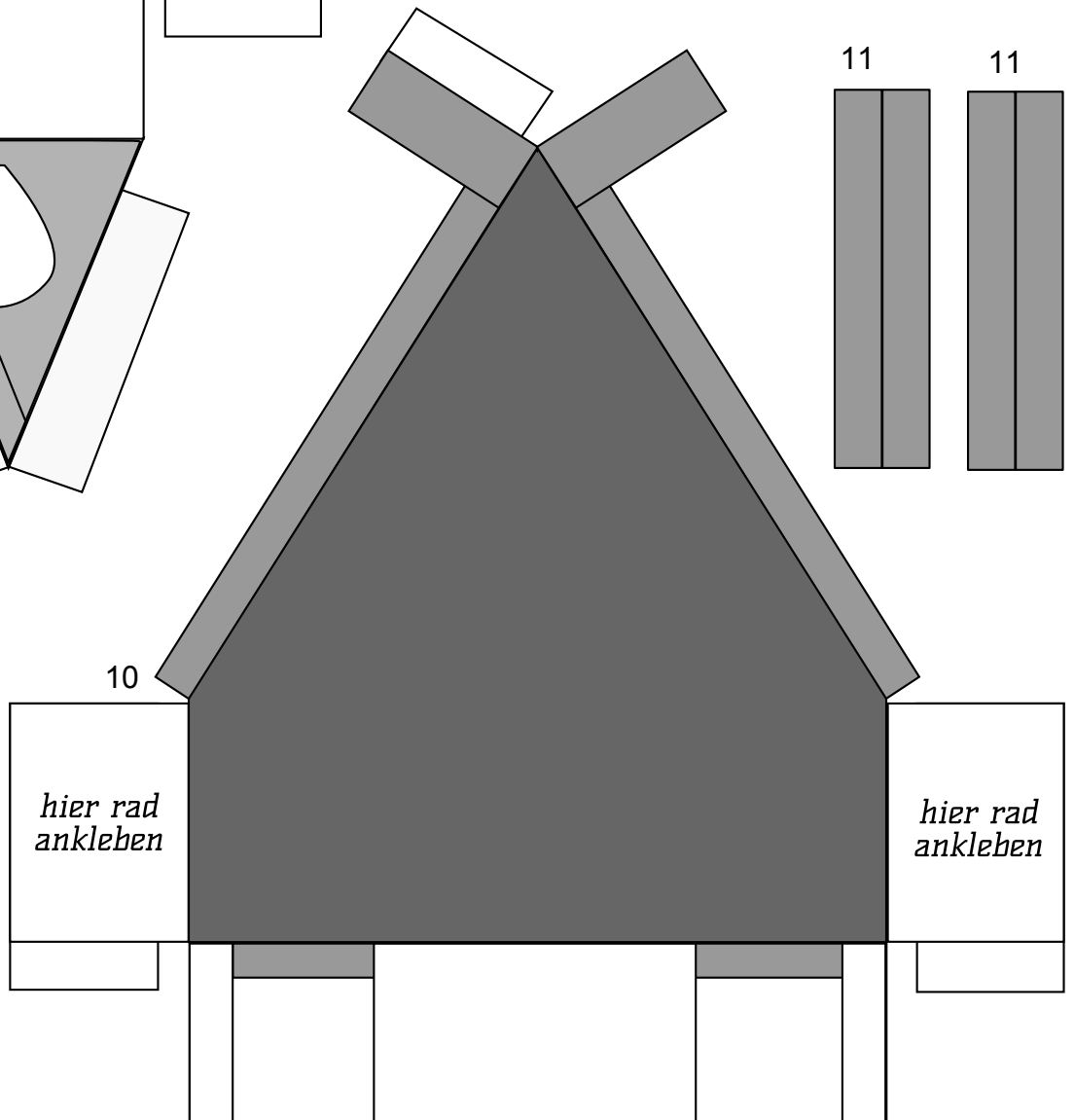
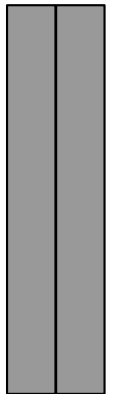

10

*hier rad
ankleben*

*hier rad
ankleben*