

# PRINOTH "BISON X"

Diese Skizze soll dir eine kleine Hilfe beim zusammenbauen des ModellRopeways PRINOTH "BISON X" sein.  
Die Nummern in der Skizze entsprechen den Nummern der jeweiligen Bogenteile.

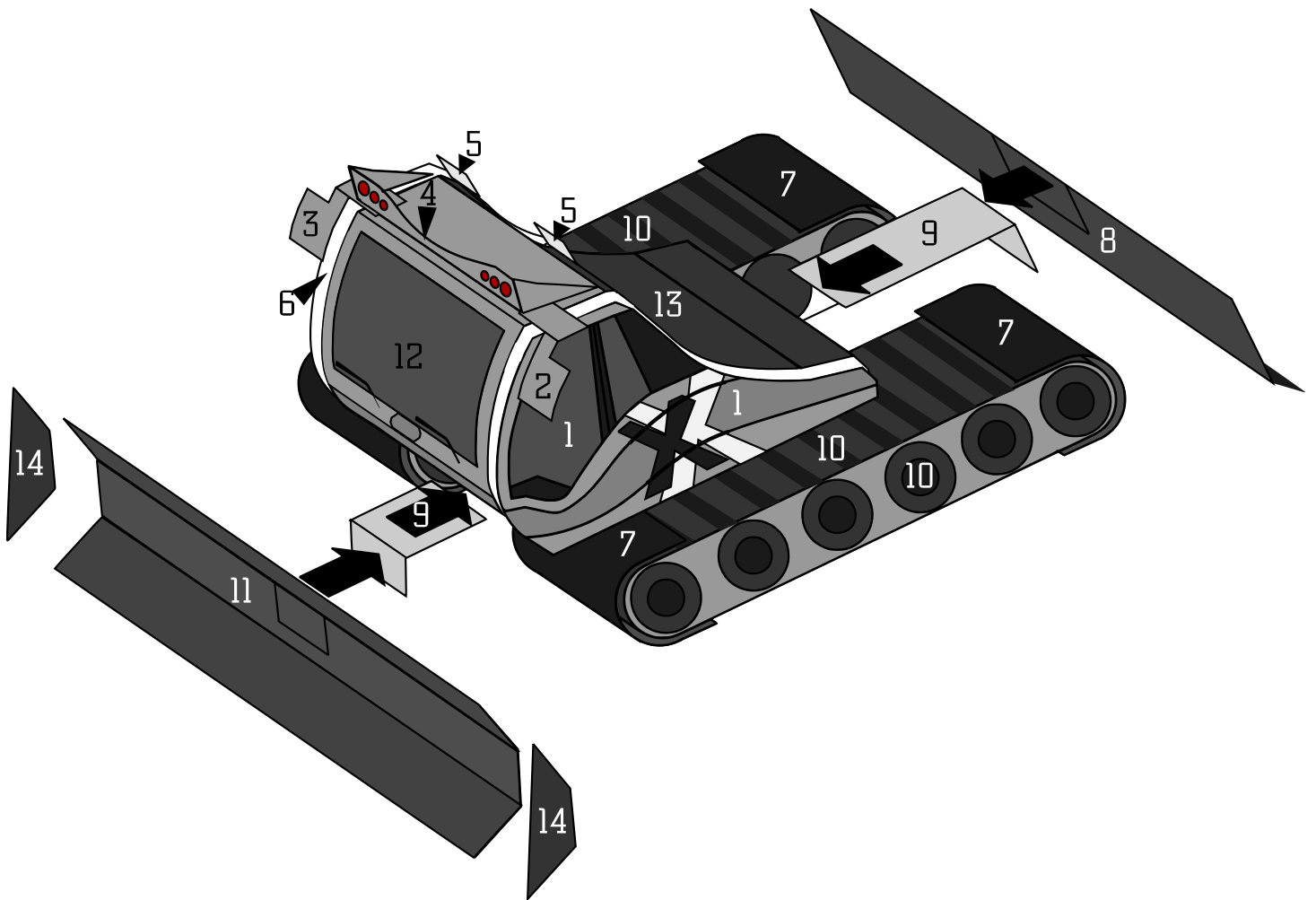

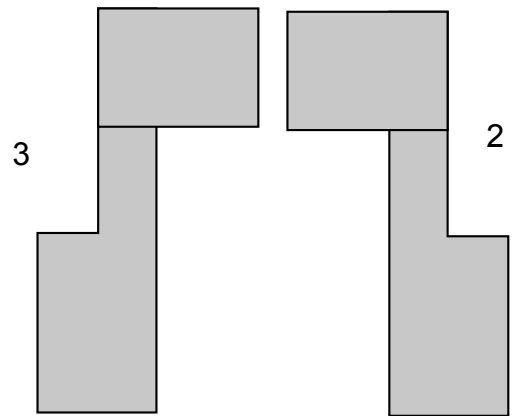

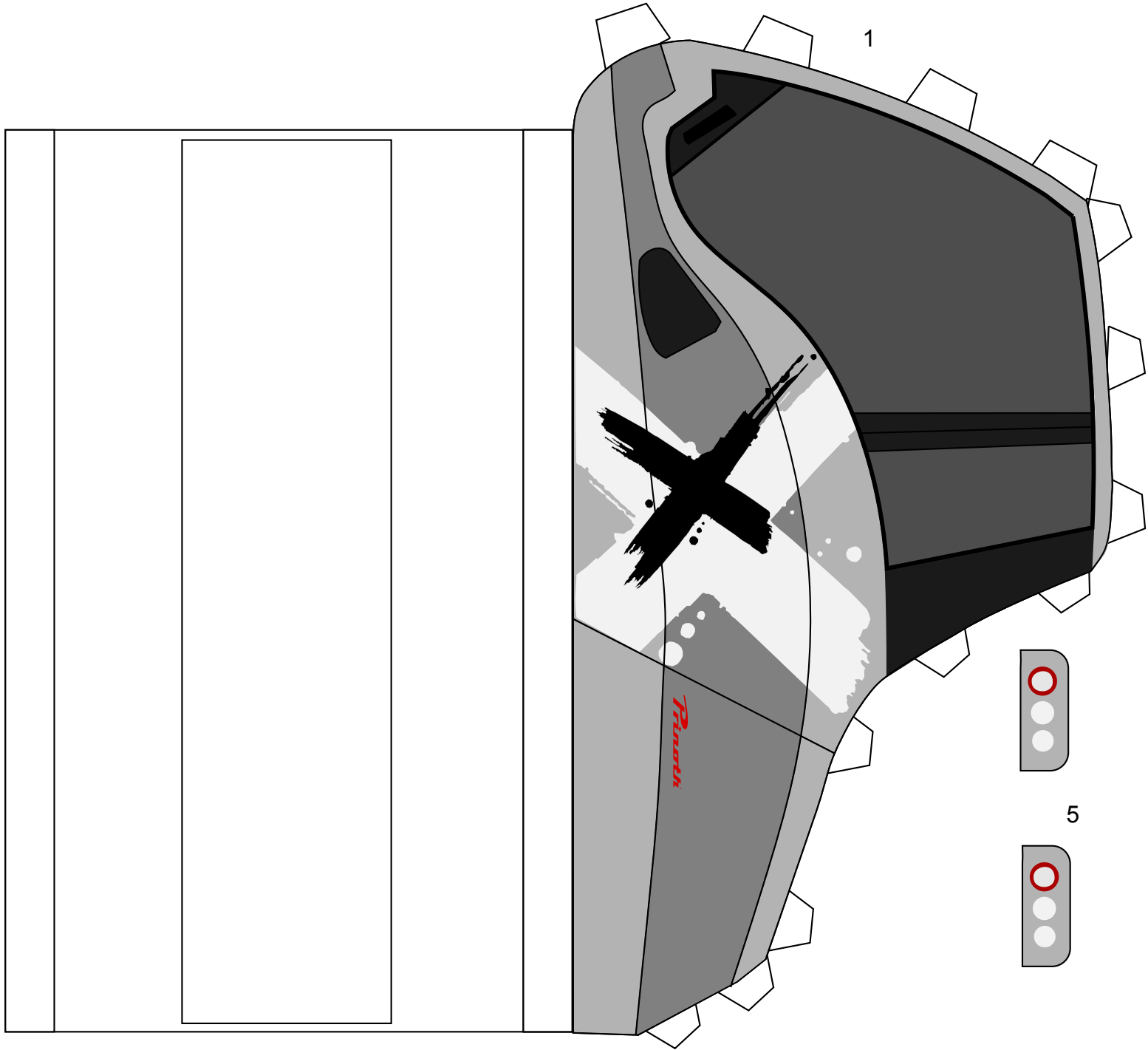
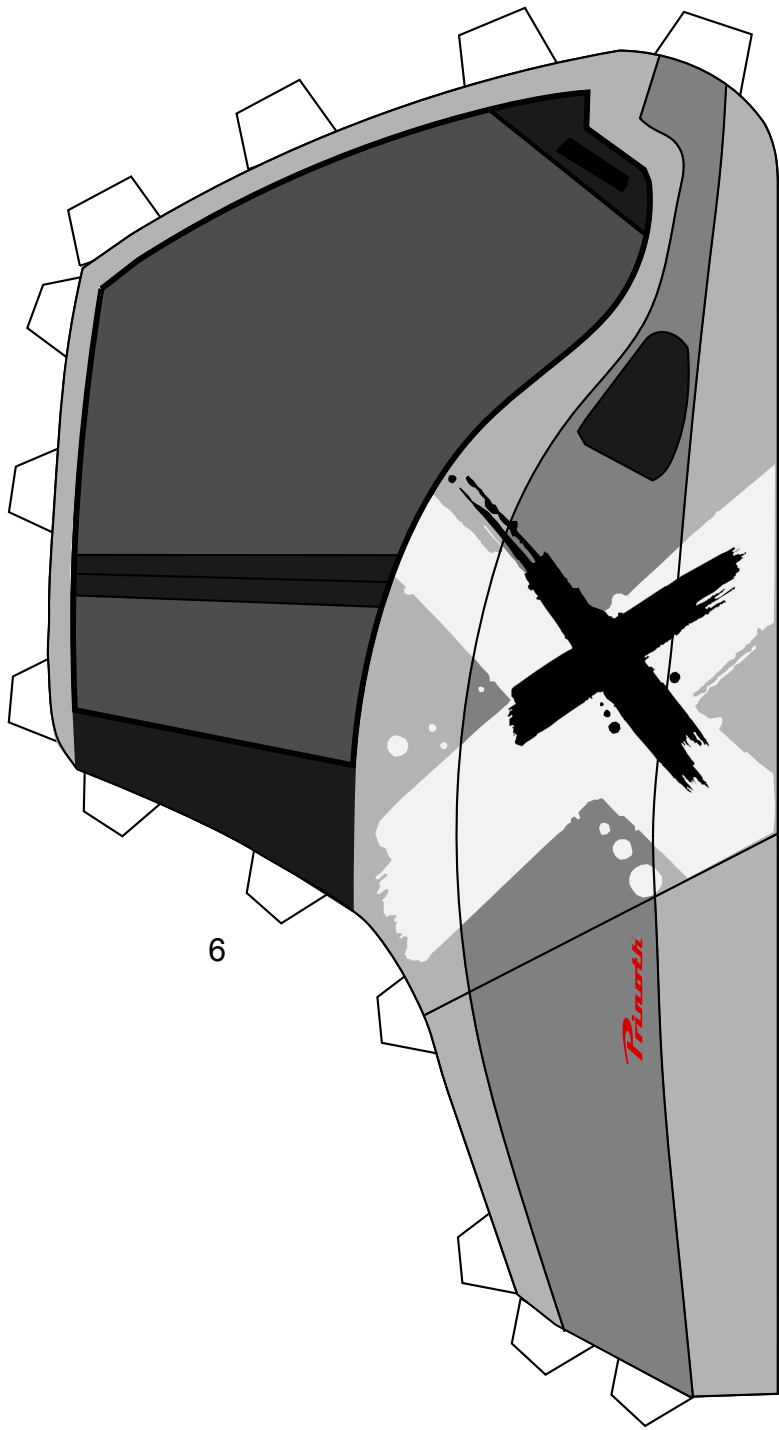

7

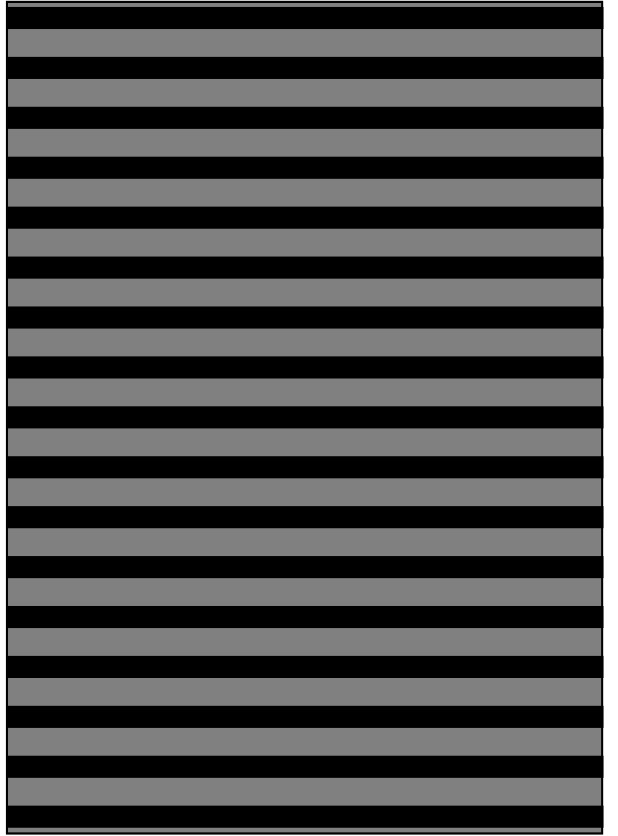

7

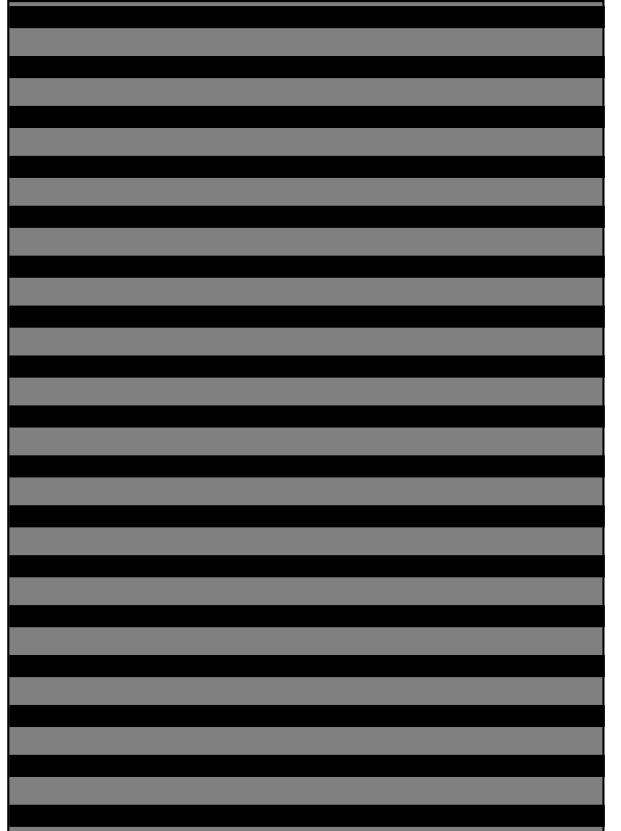

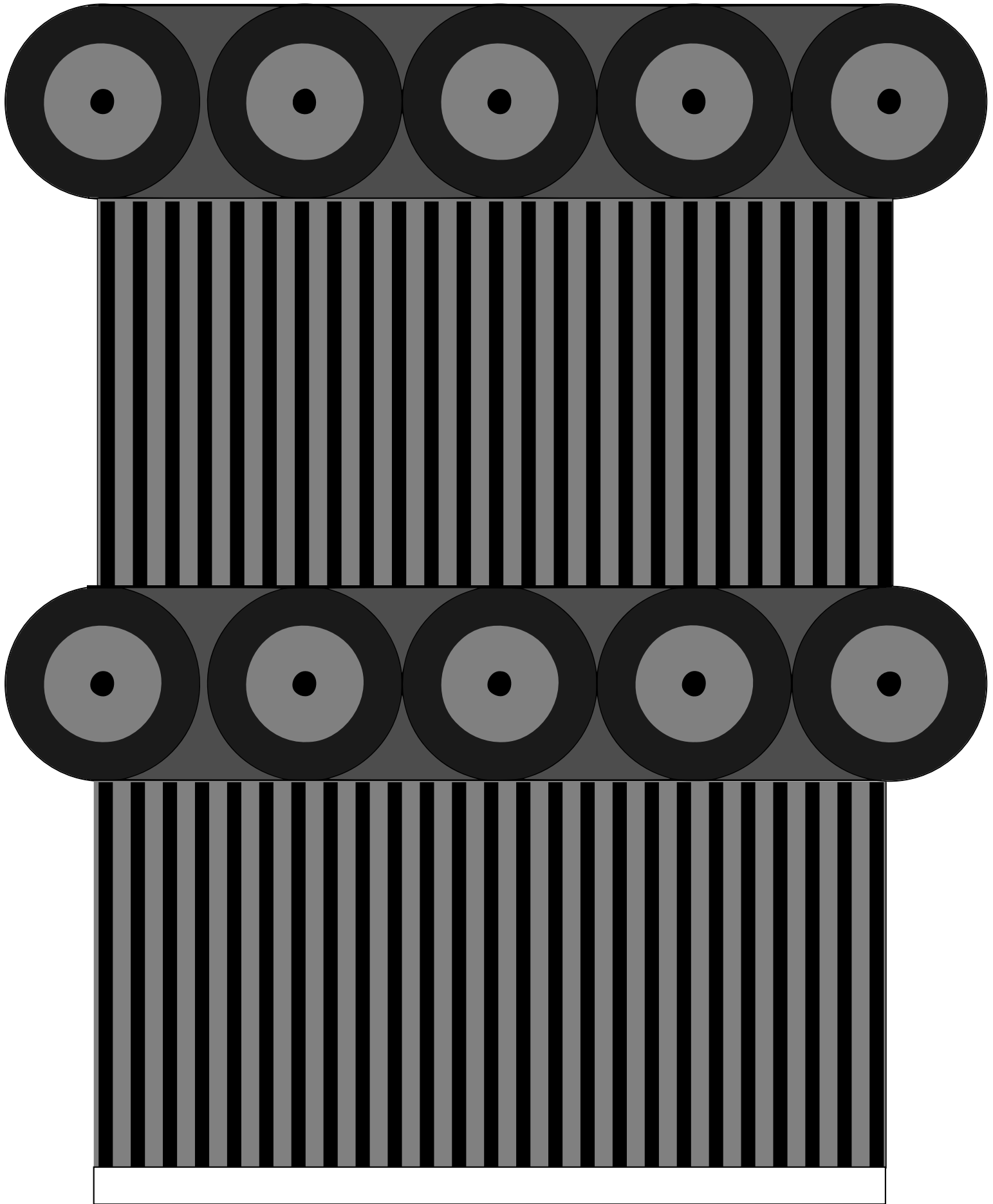

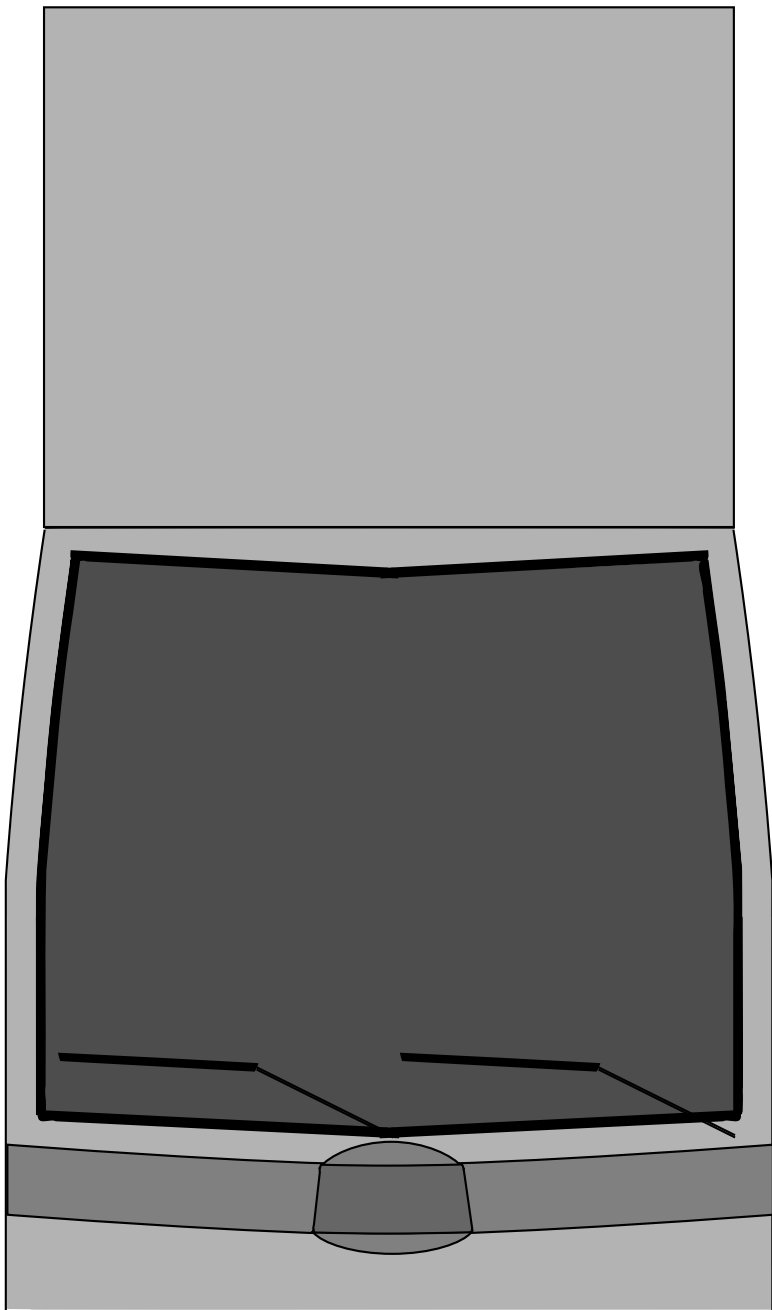

12

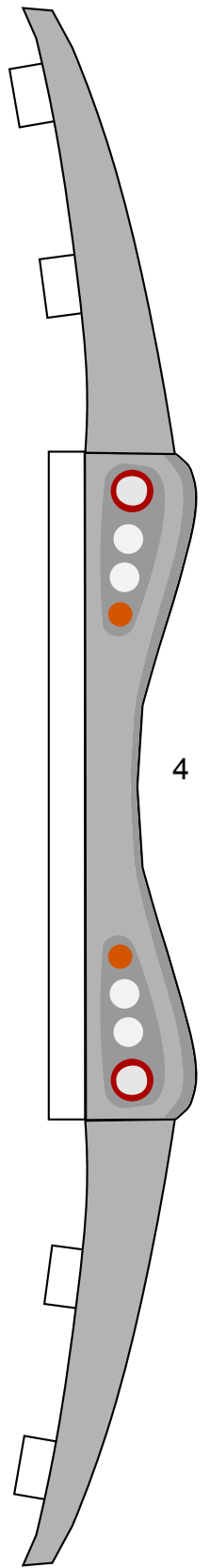

4



13

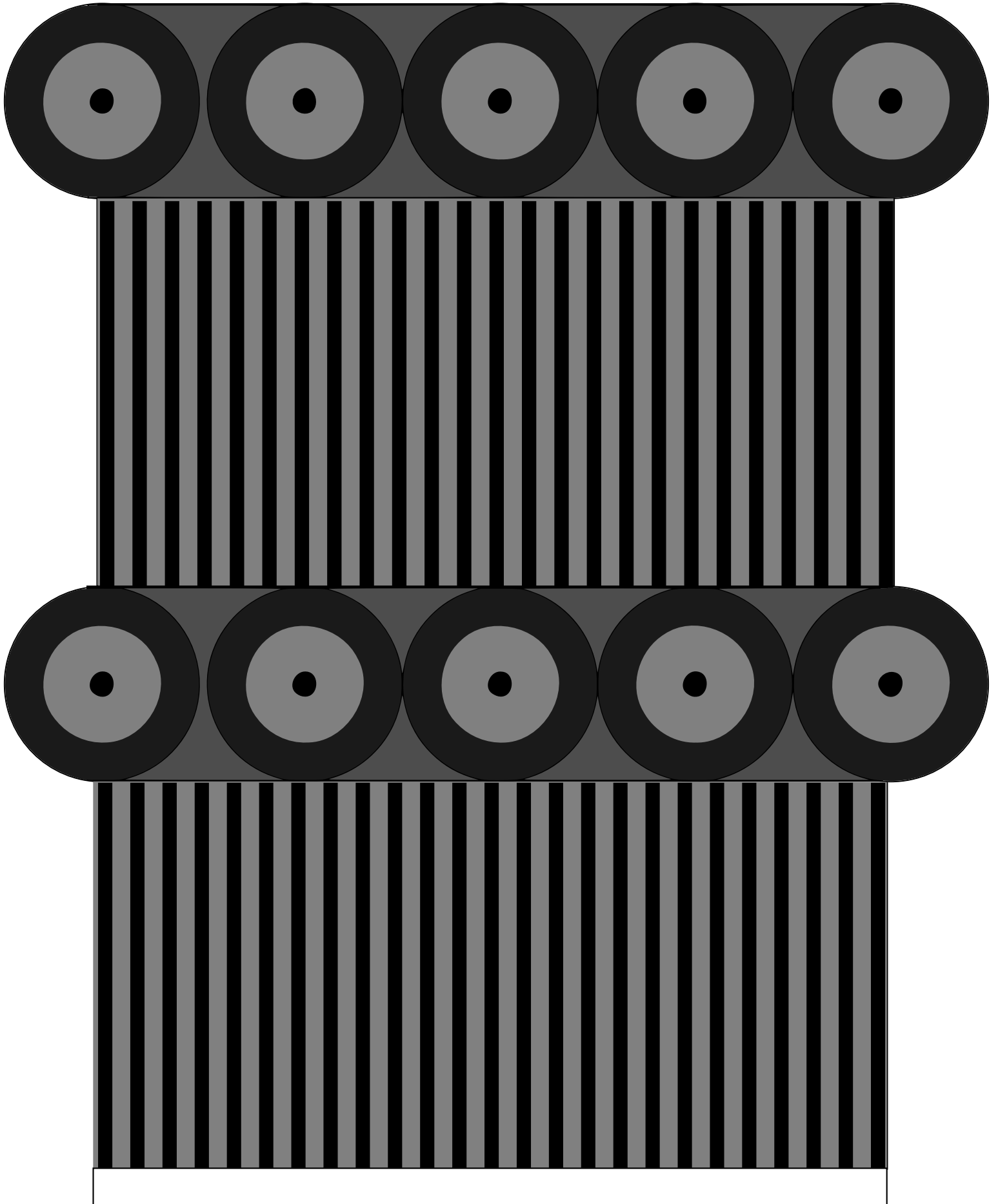

7

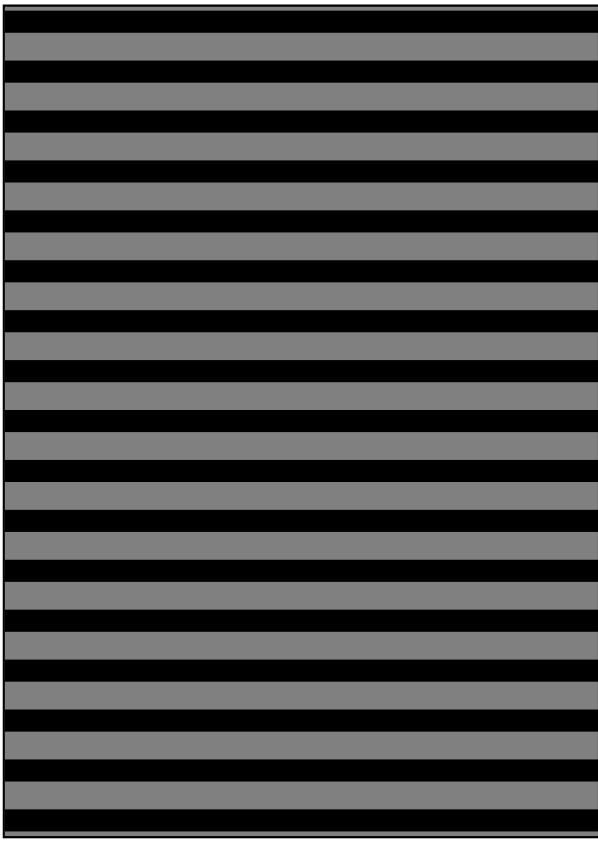

7

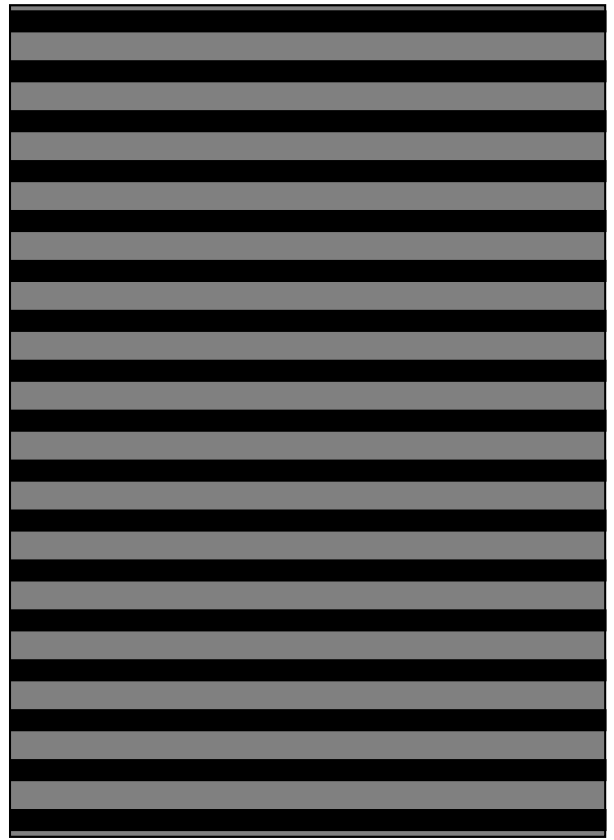

9



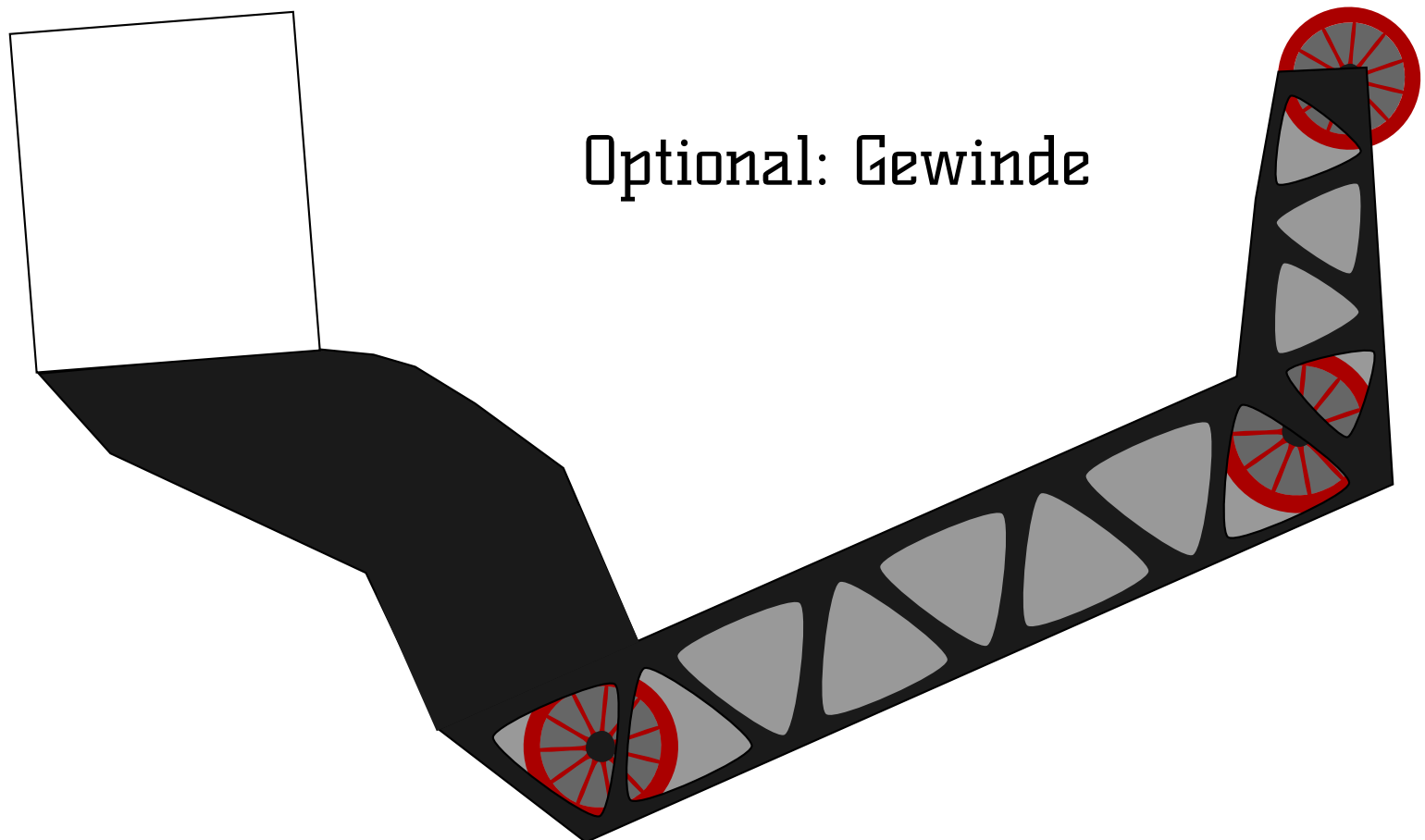



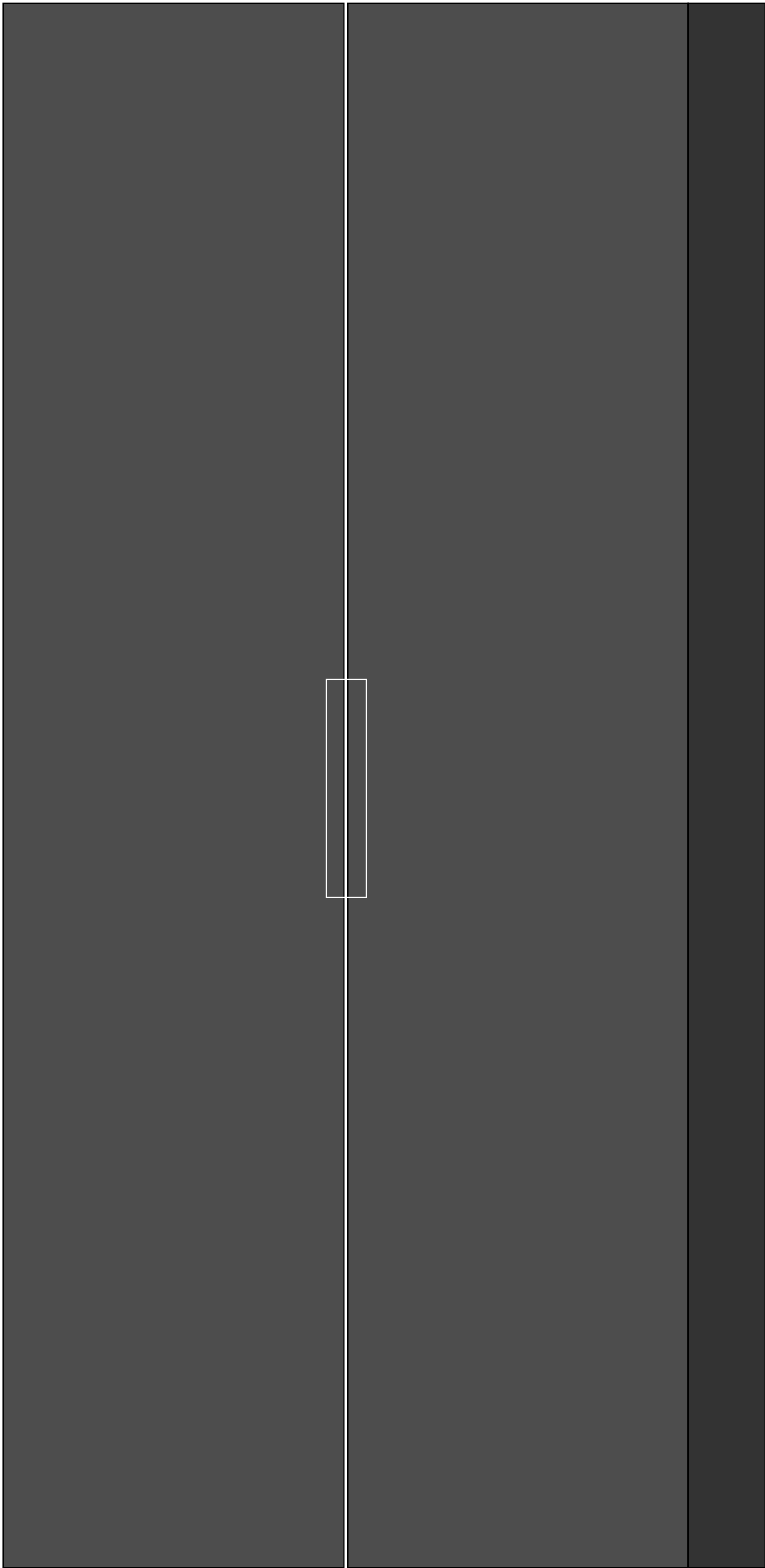

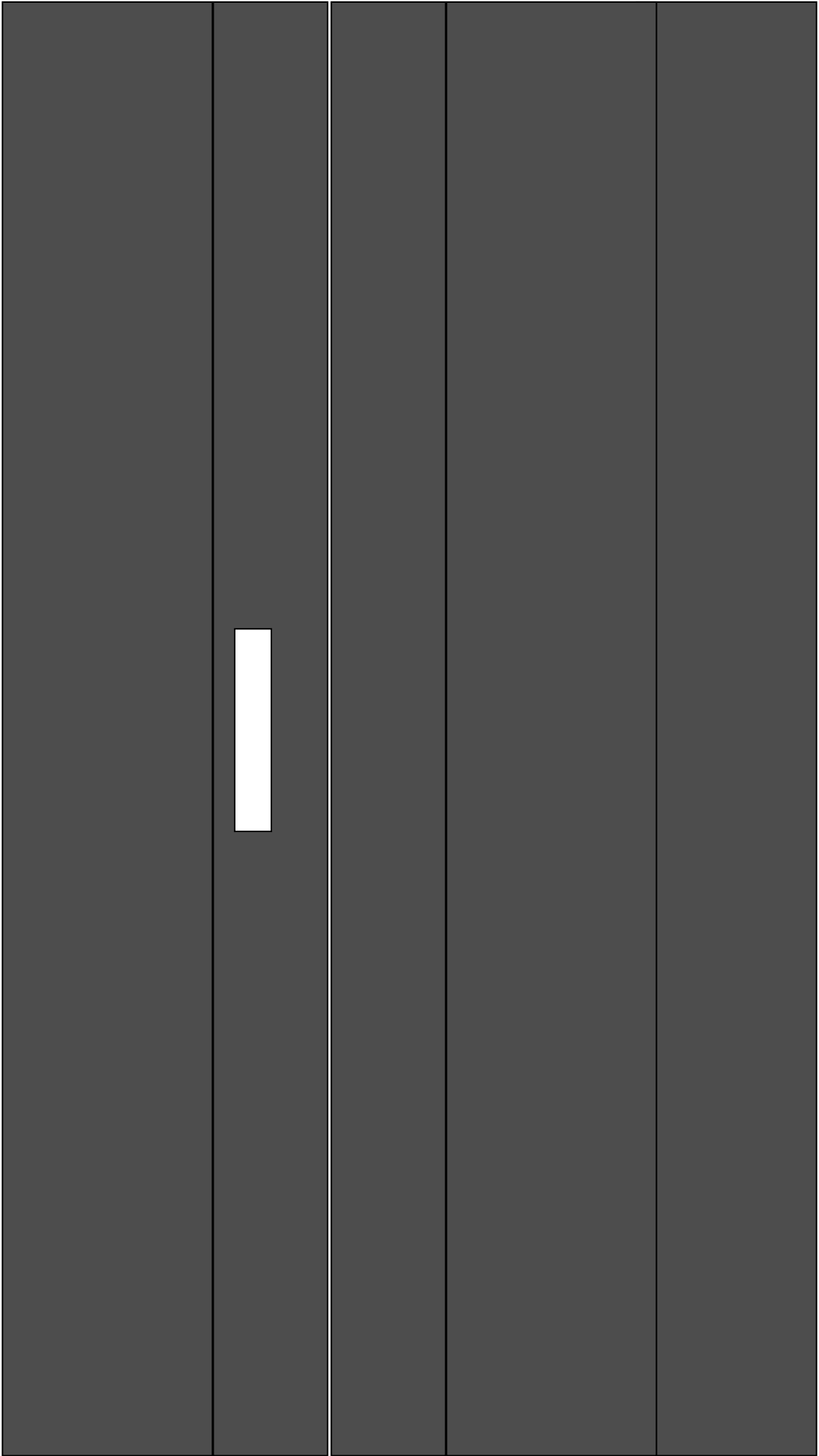

14

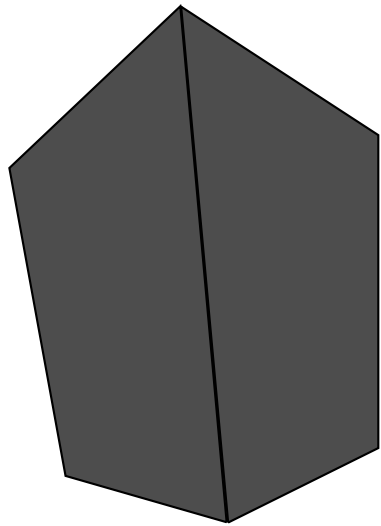

14

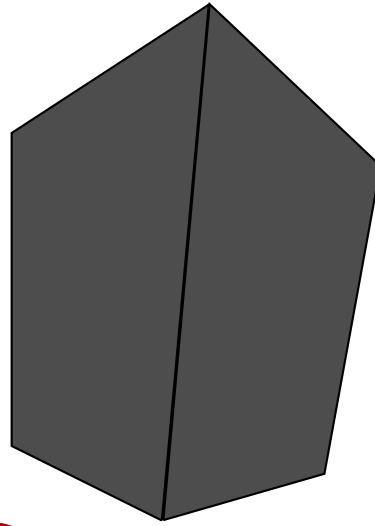

Optional: Gewinde