

PRINOTH "BEAST"

Diese Skizze soll dir eine kleine Hilfe beim zusammenbauen des ModellRopeways PRINOTH "BEAST" sein.
Die Nummern in der Skizze entsprechen den Nummern der jeweiligen Bogenteile.

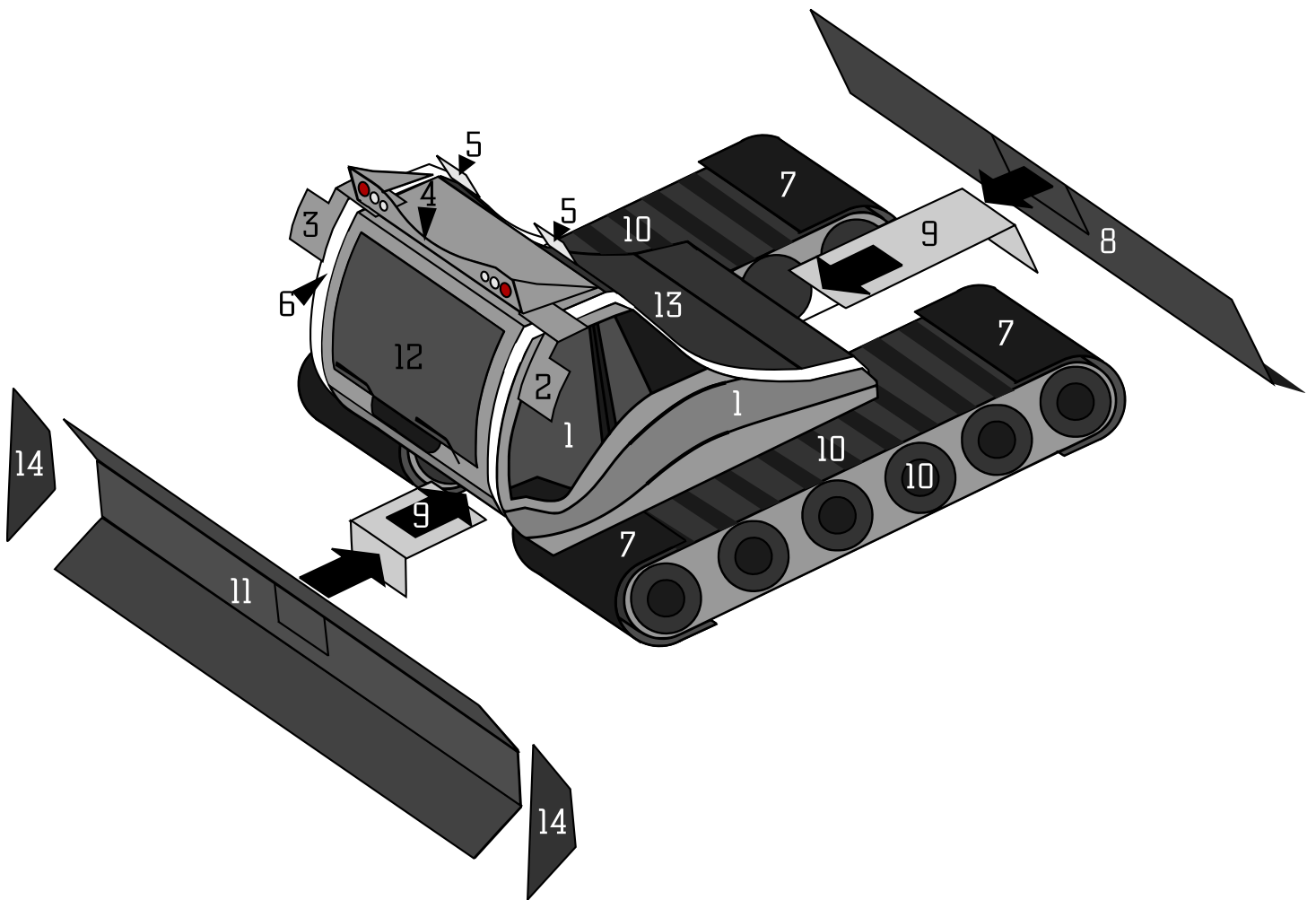

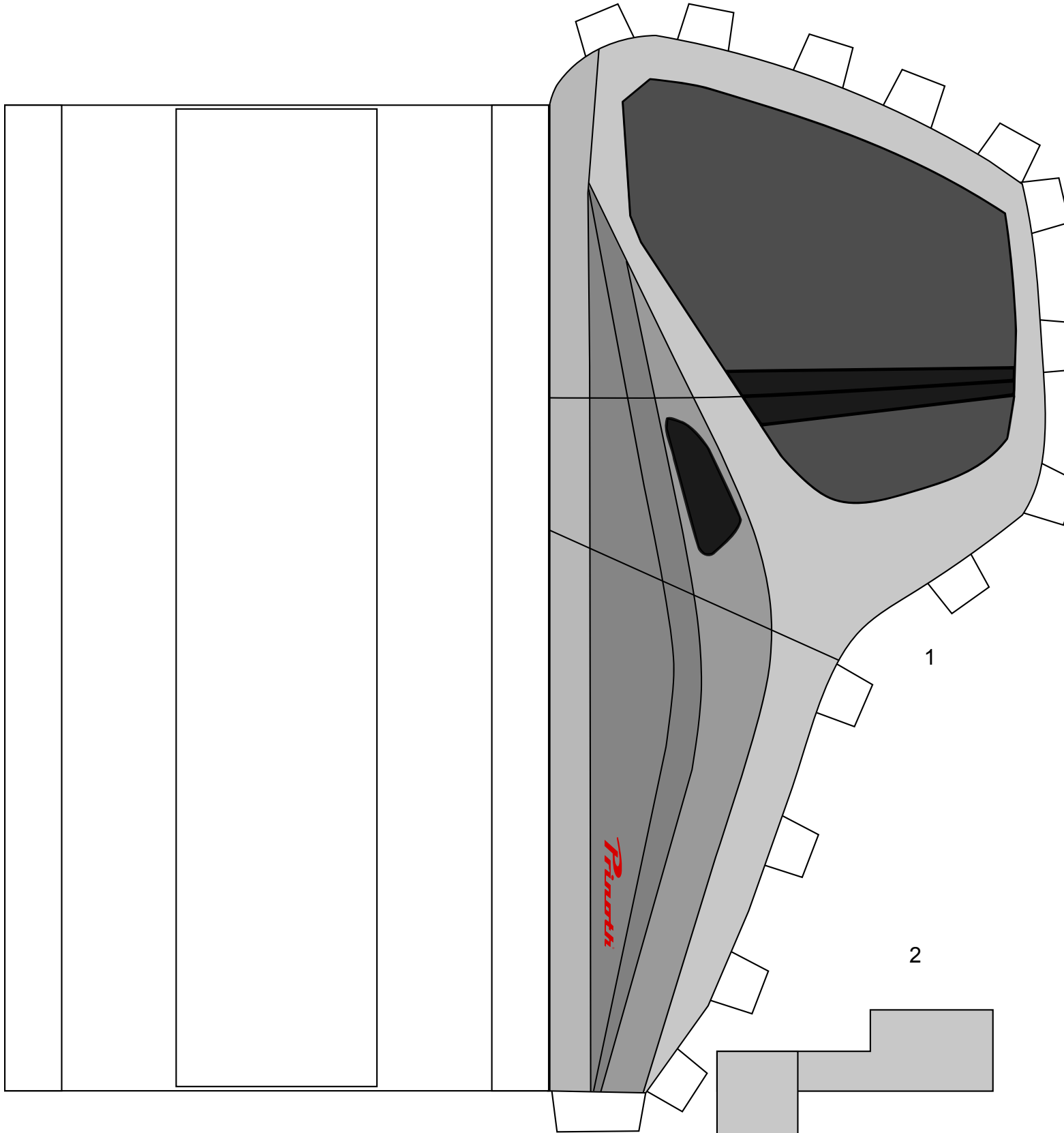

1

2

3

4

5

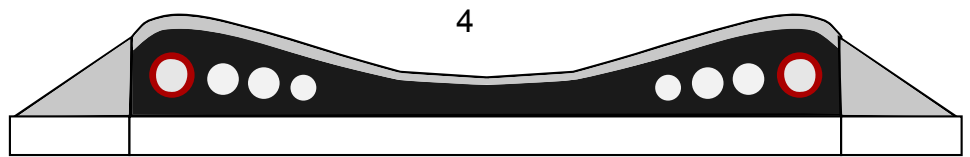
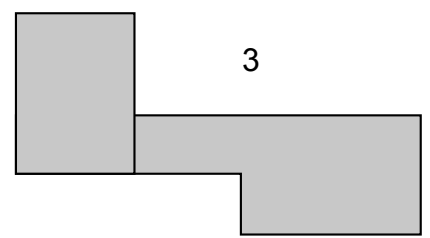
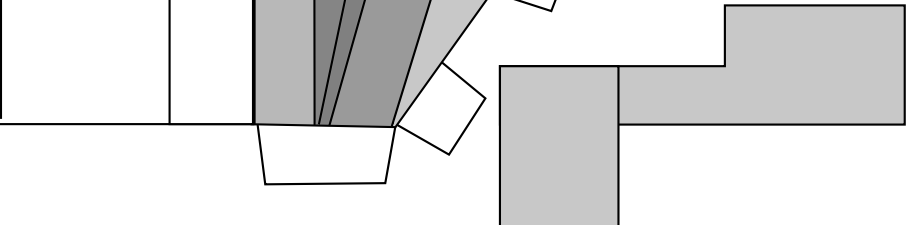
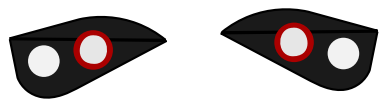

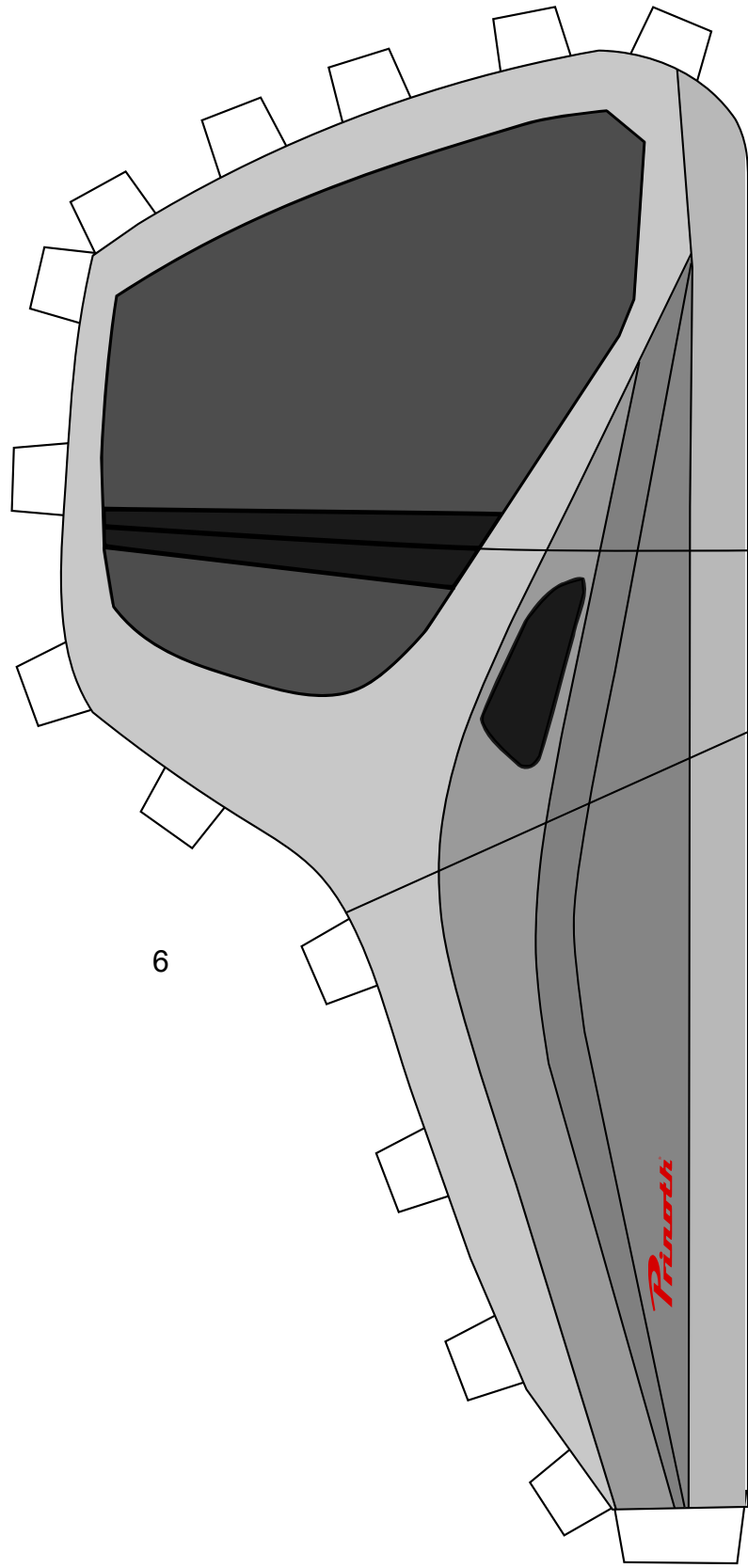

7

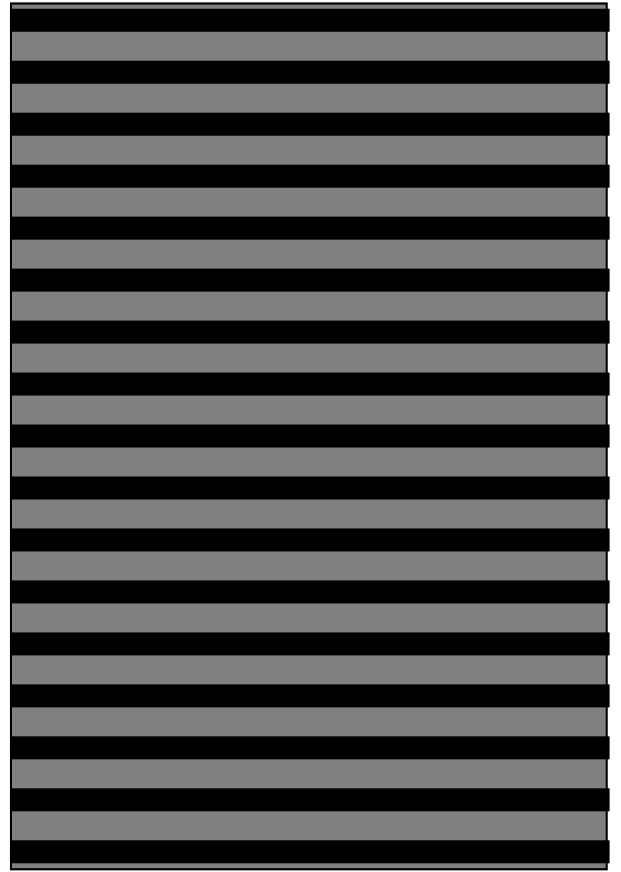

7

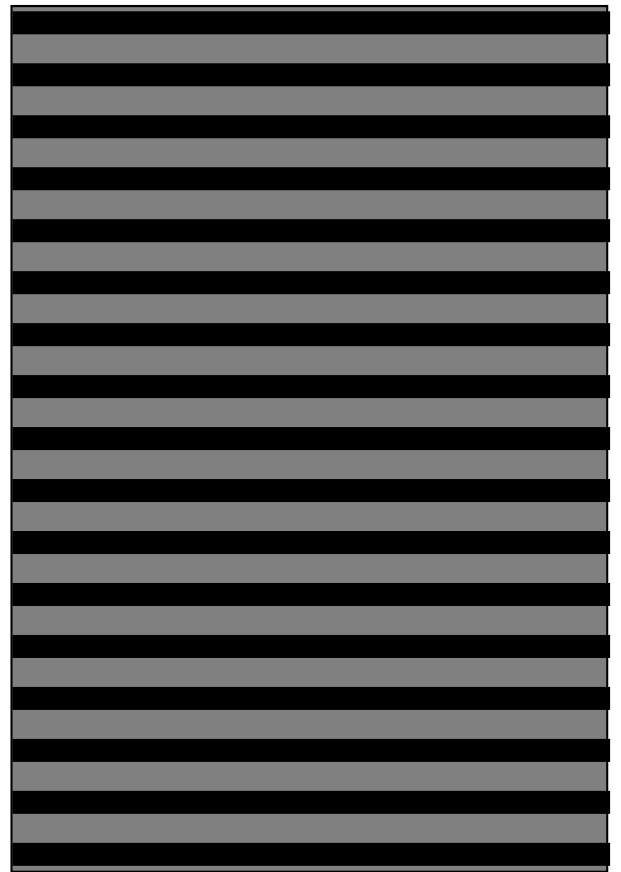

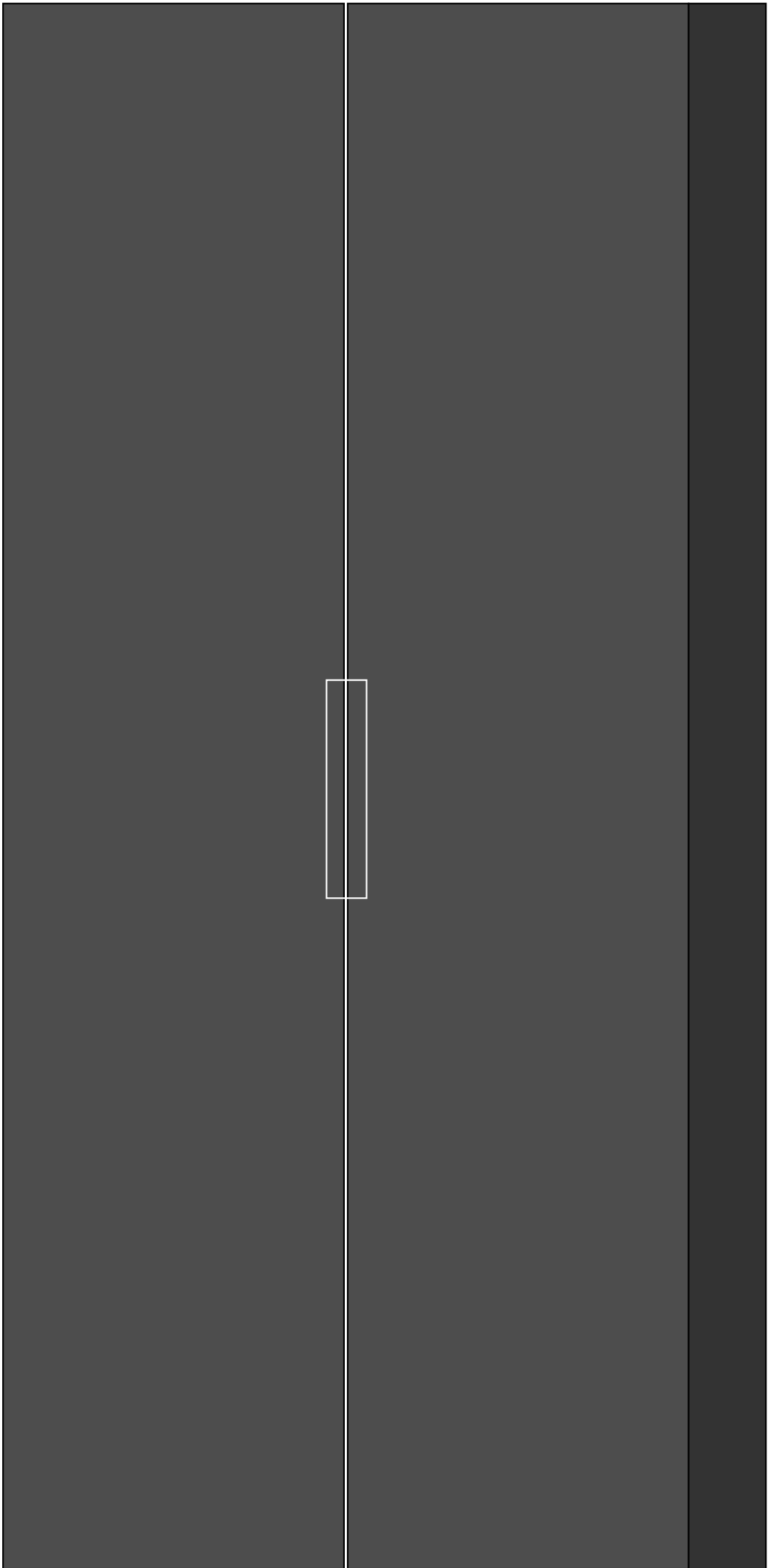

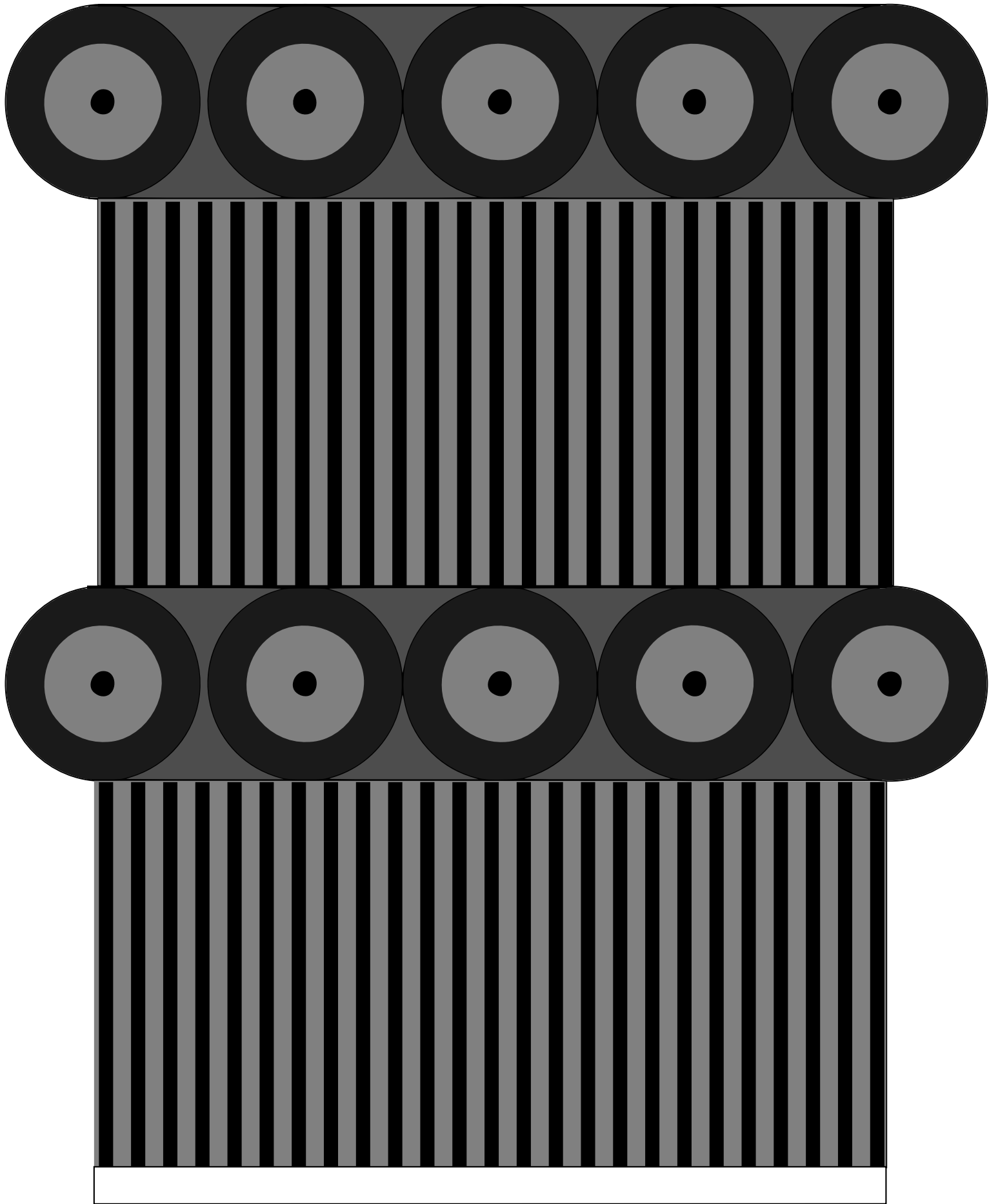

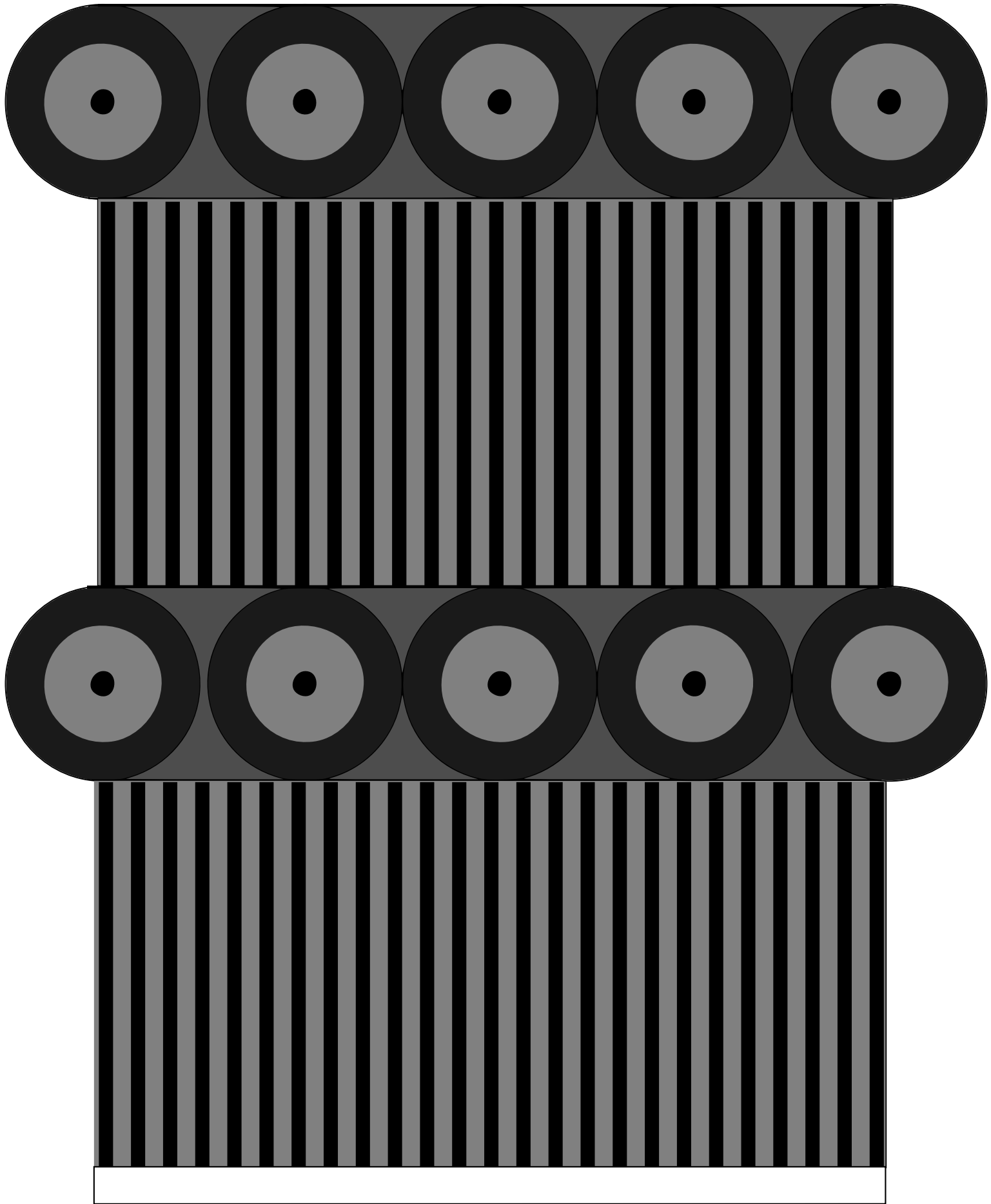

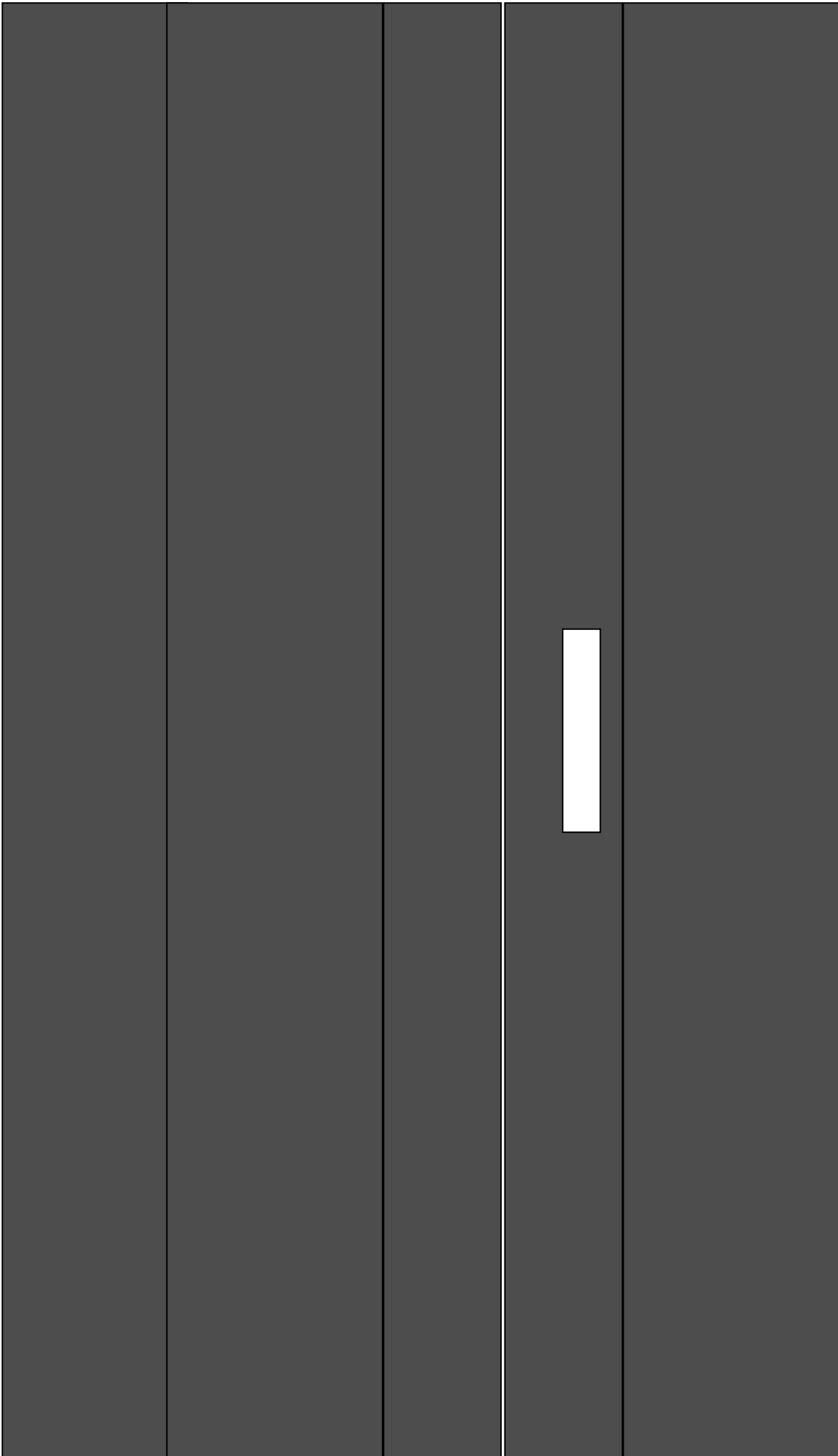

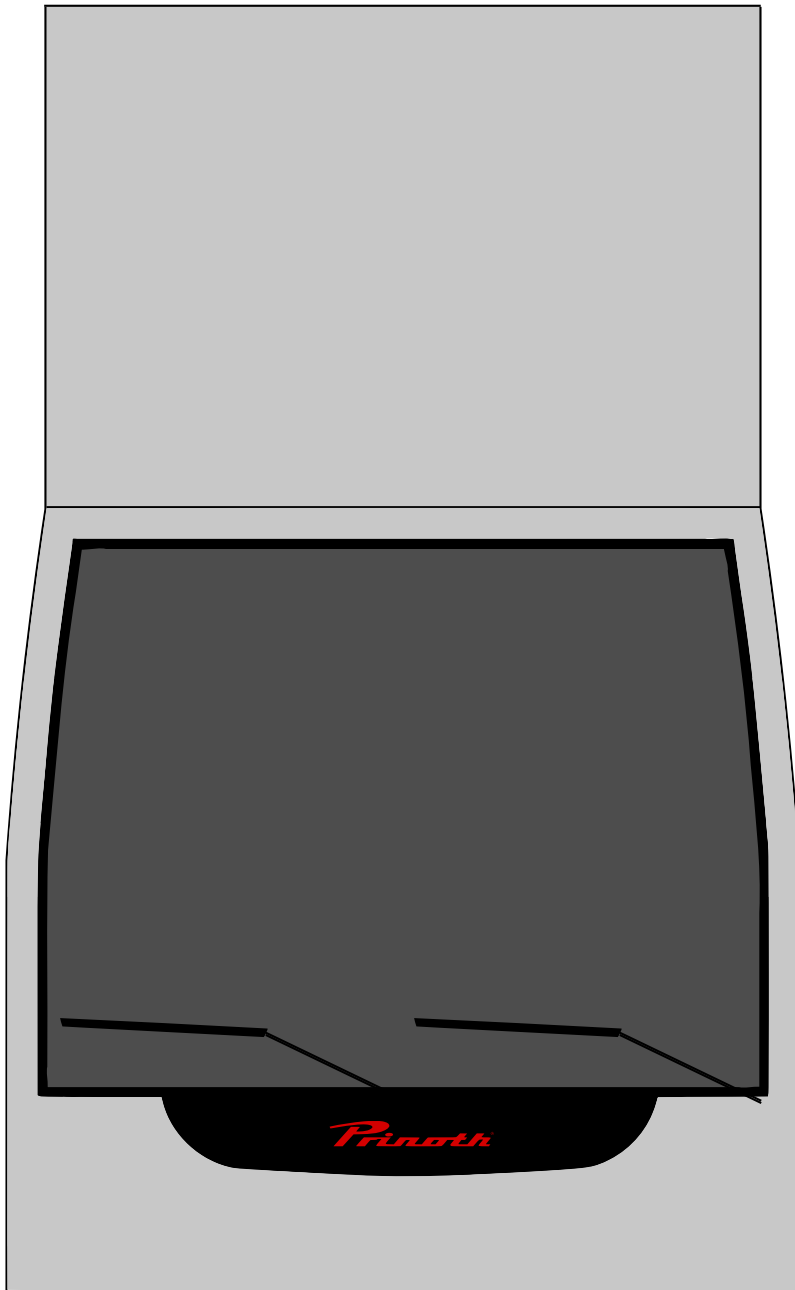

12

13

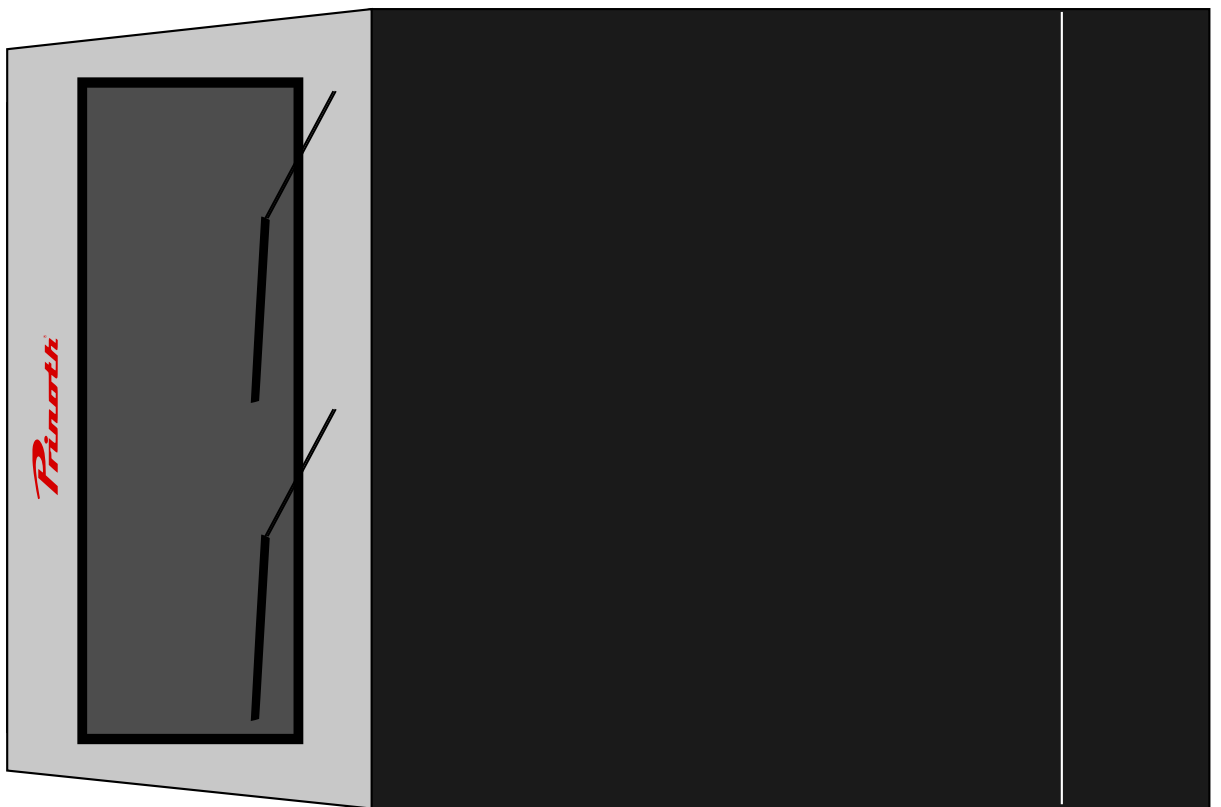

7

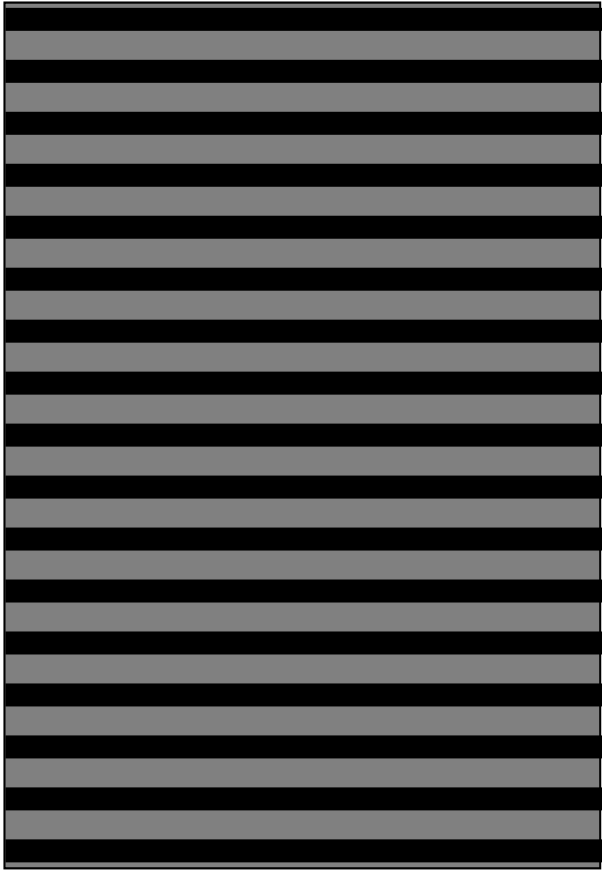

7

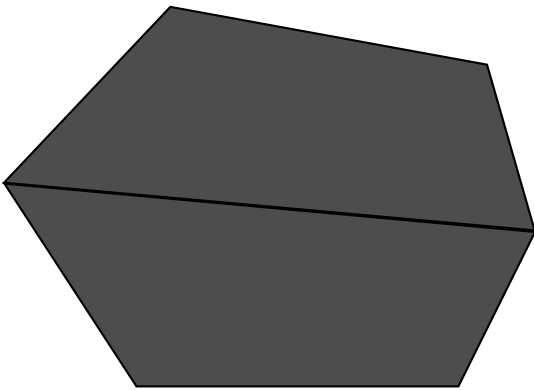
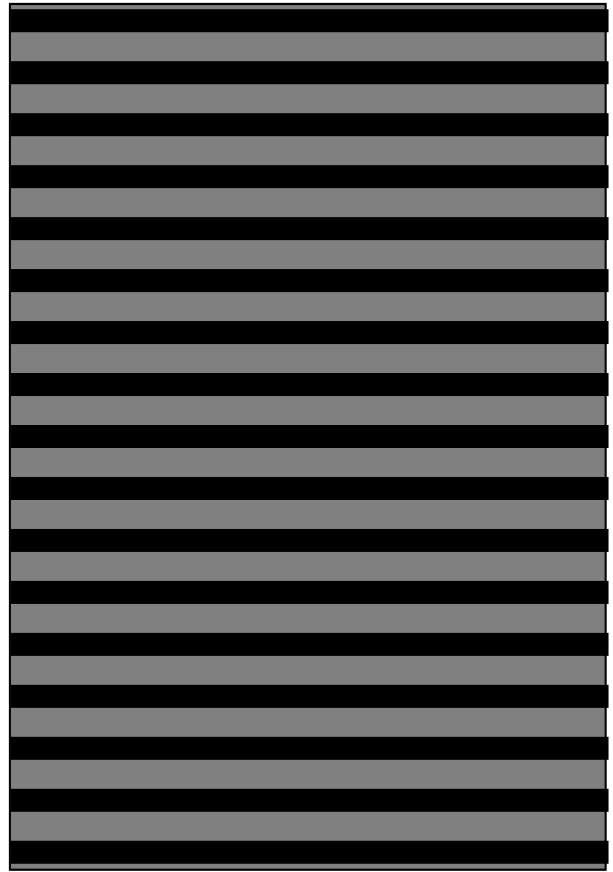

14

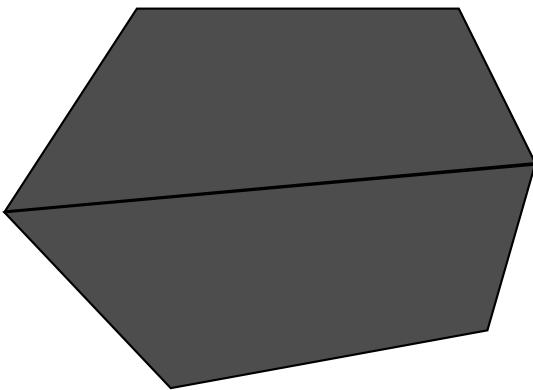

14

Optimal: Winde

