

PISTENBULLY 100

Diese Skizze soll dir eine kleine Hilfe beim zusammenbauen des ModellRopeways PISTENBULLY 100 sein.
Die Nummern in der Skizze entsprechen den Nummern der jeweiligen Bauteile.

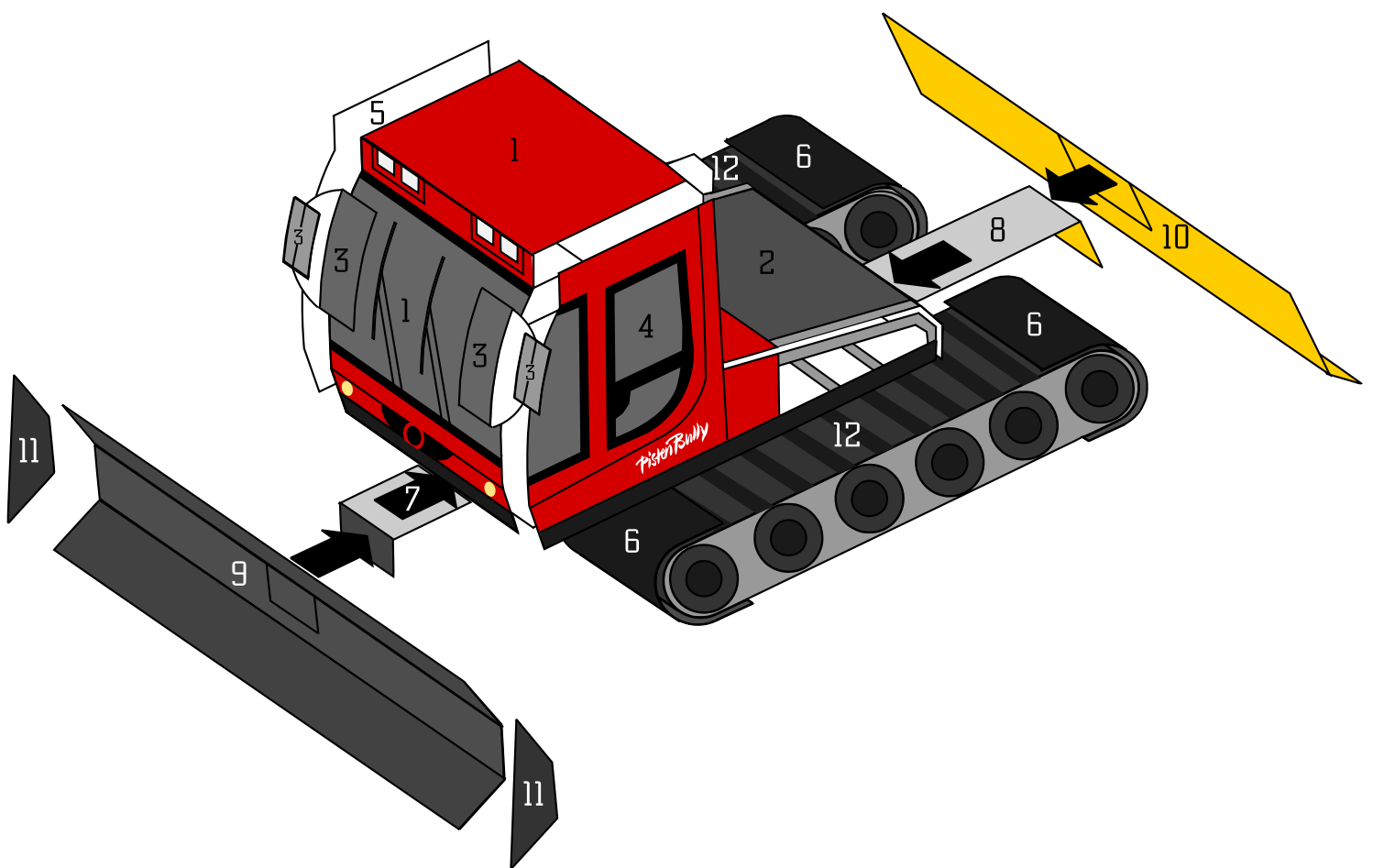

1

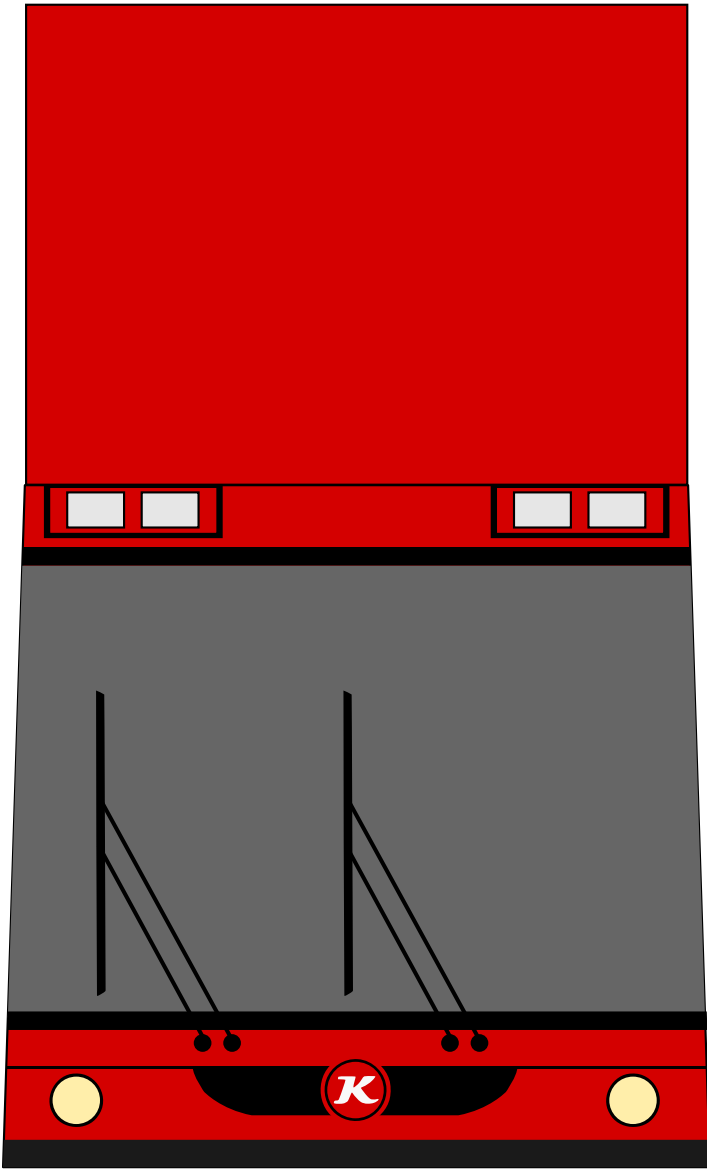

3

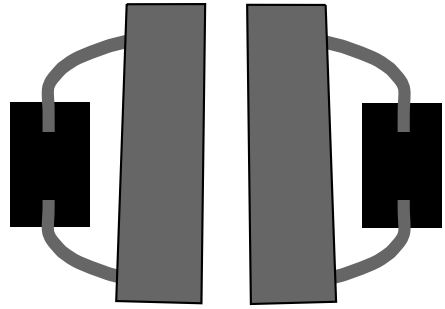

2

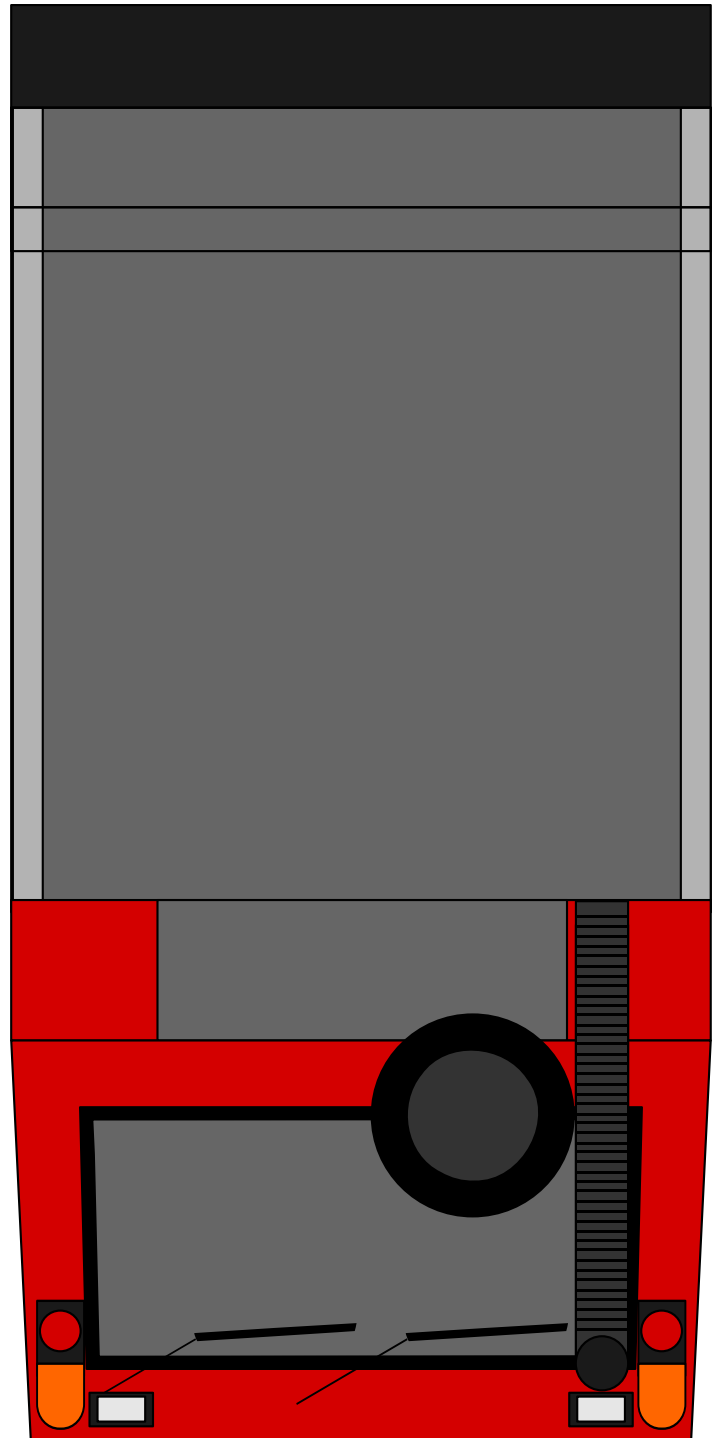

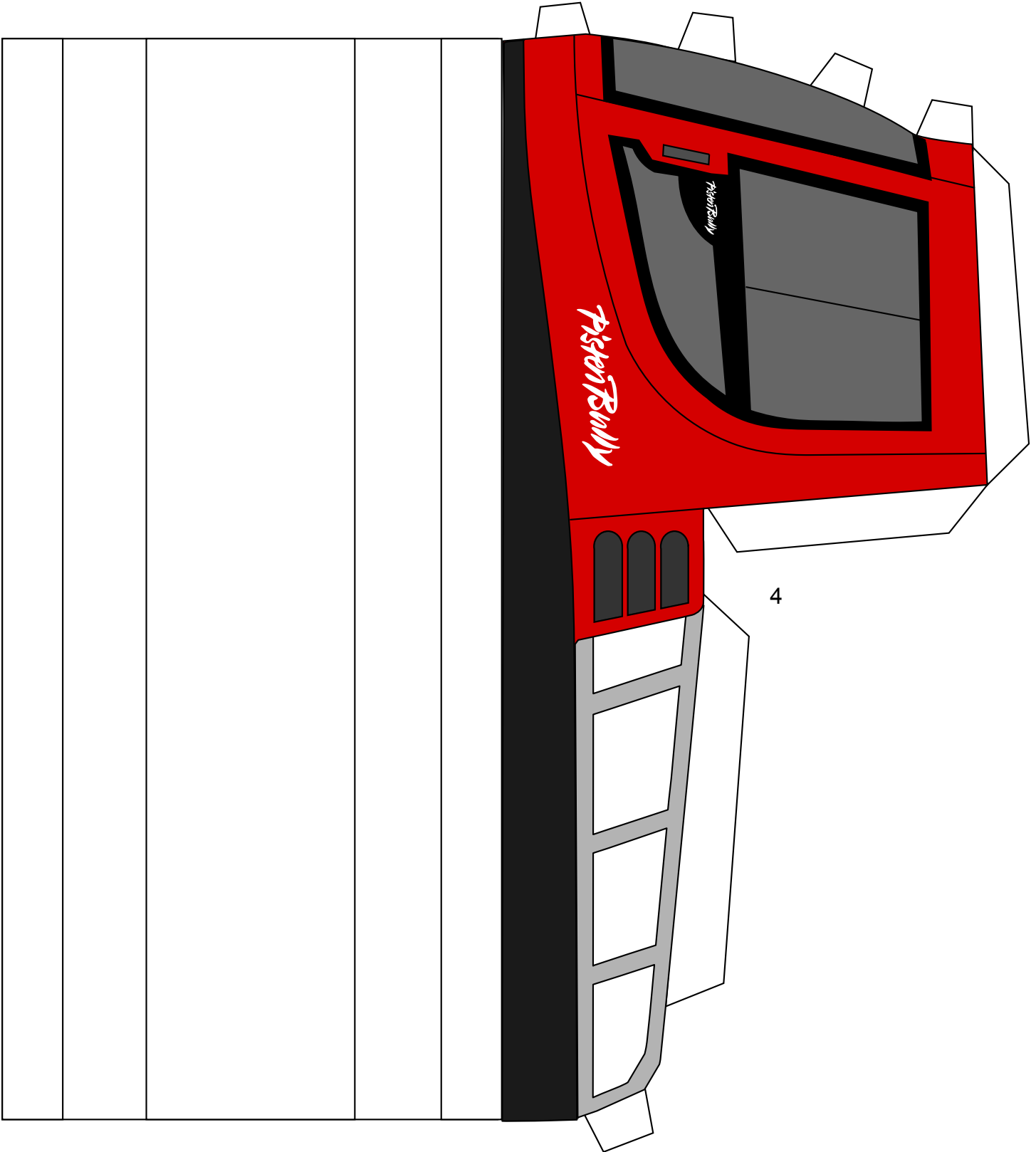

4

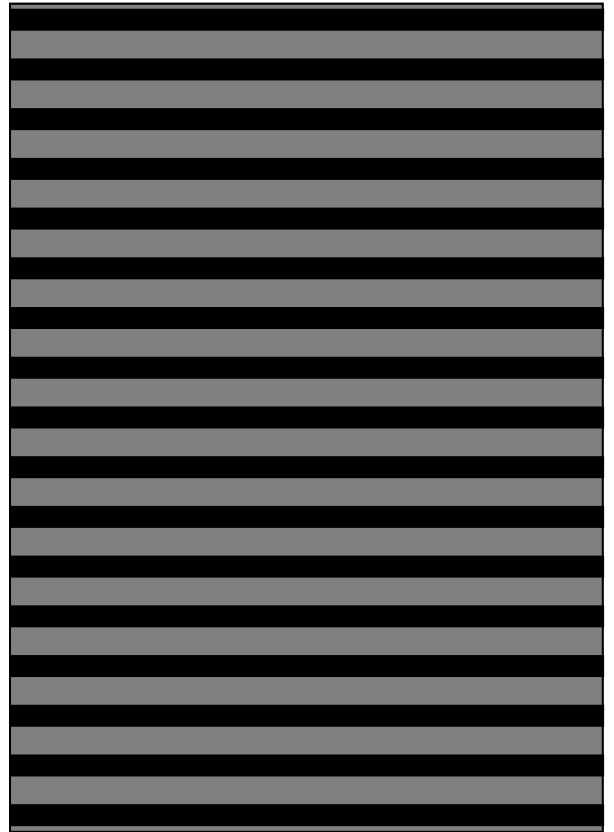
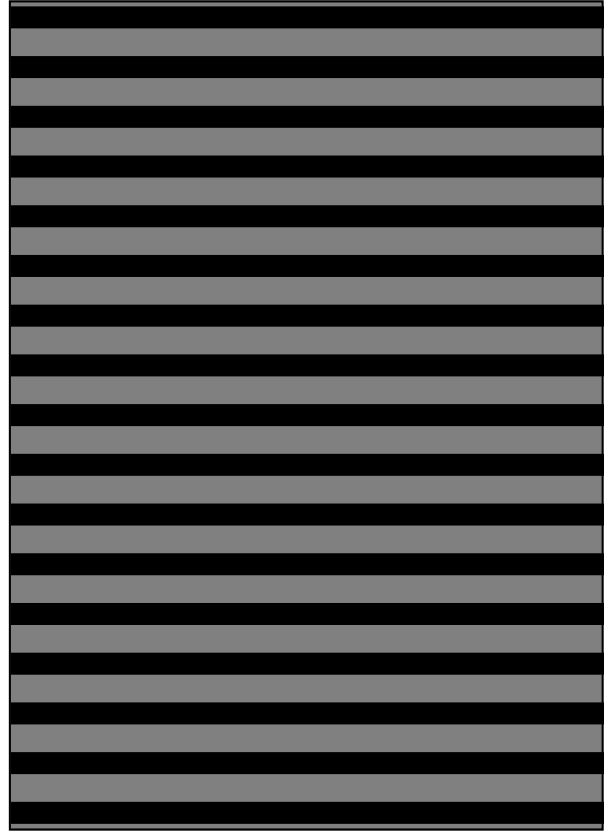
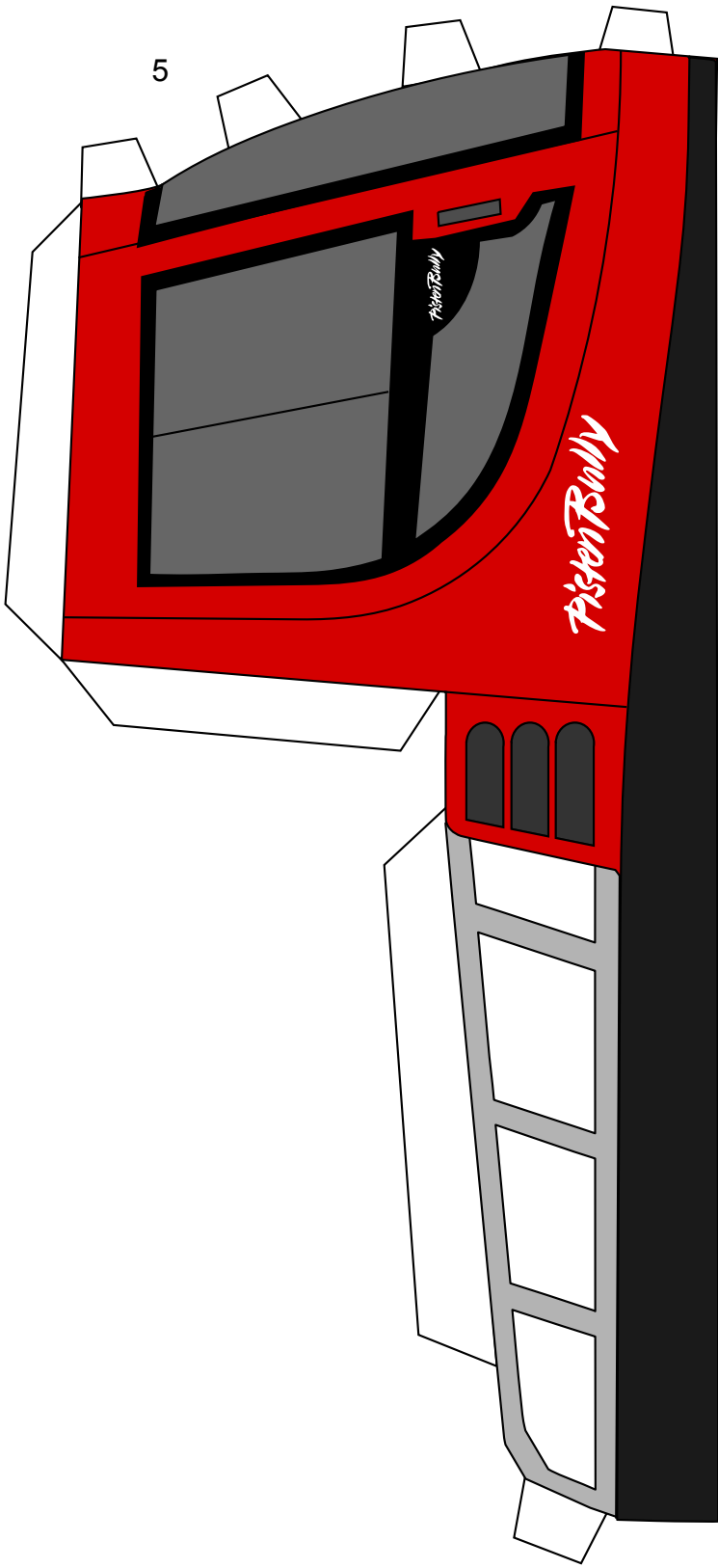

7

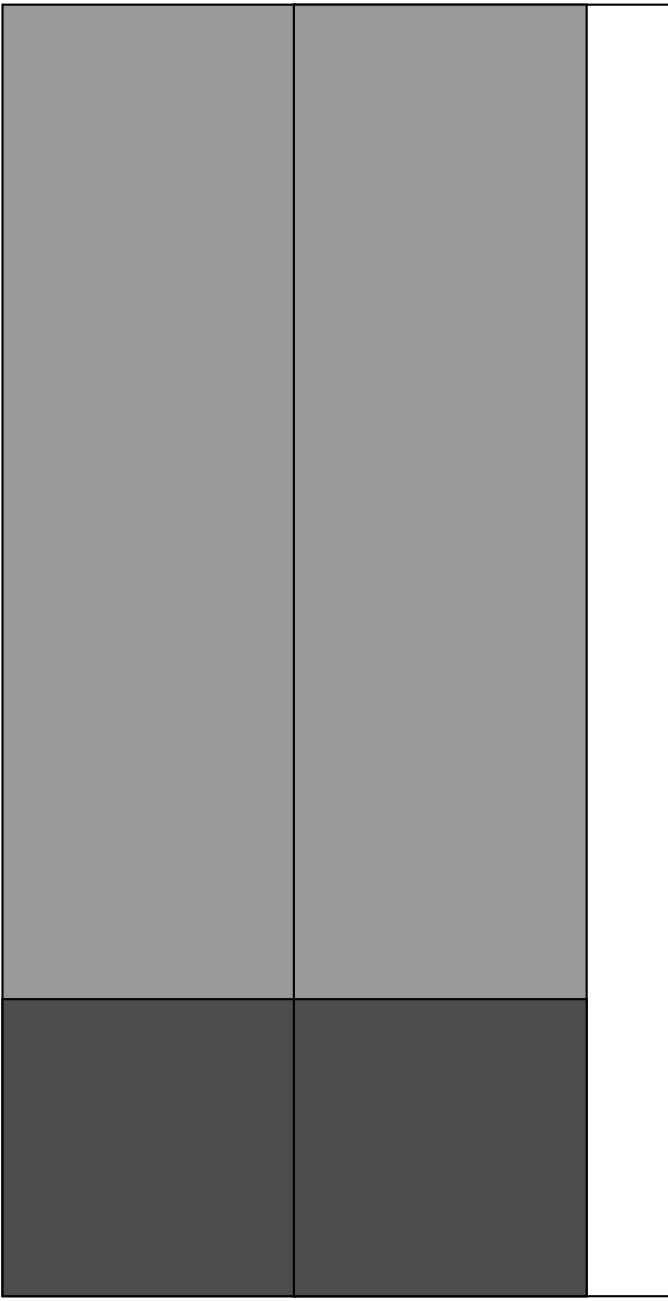

8

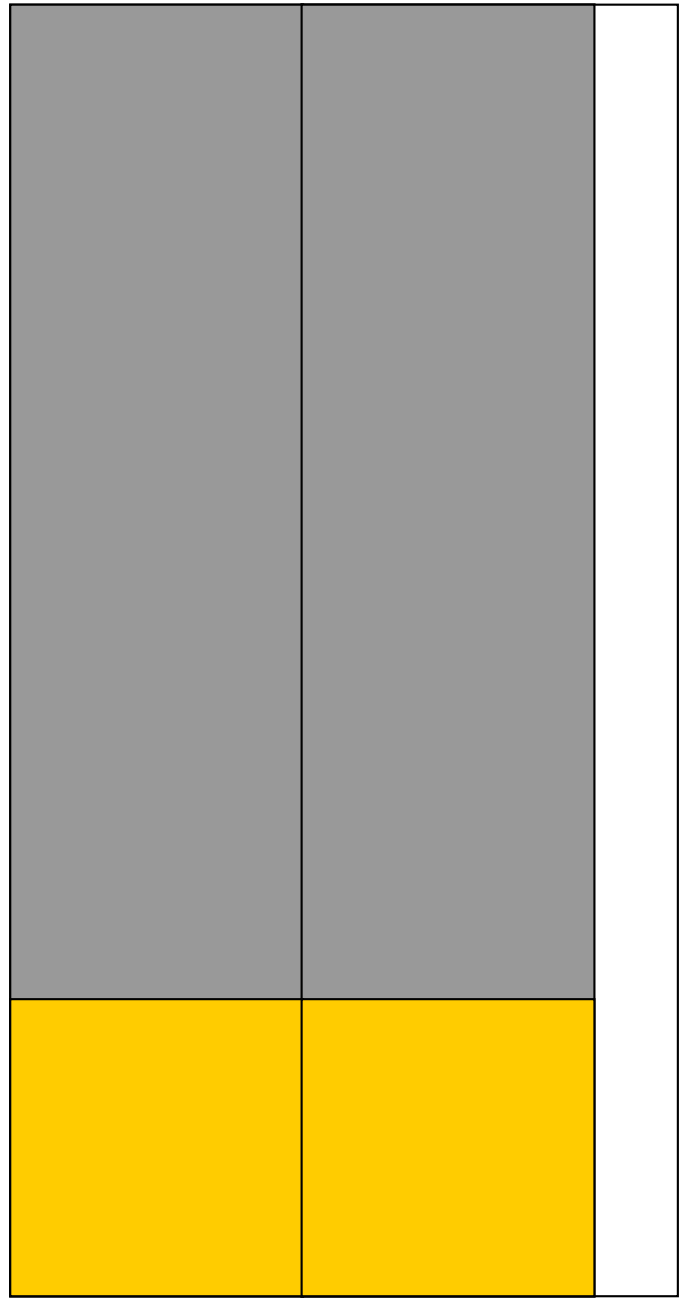

6

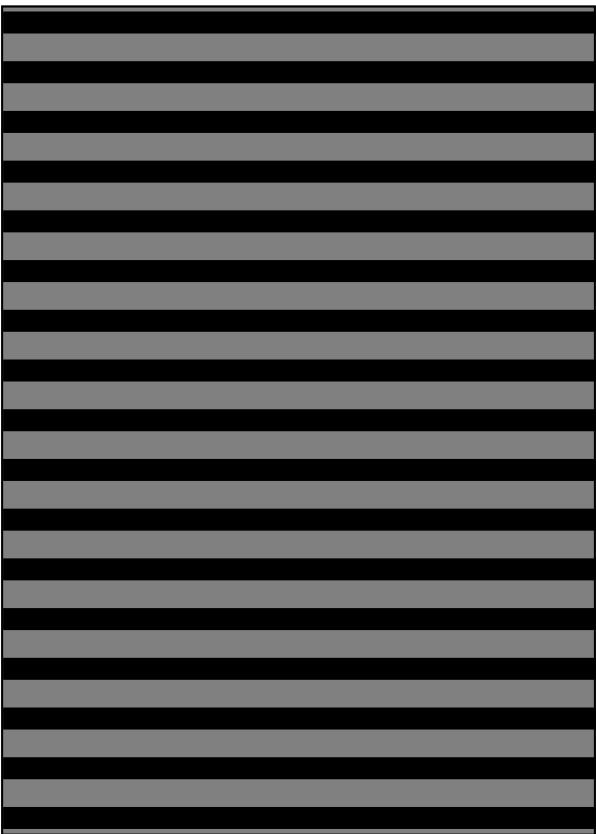

6

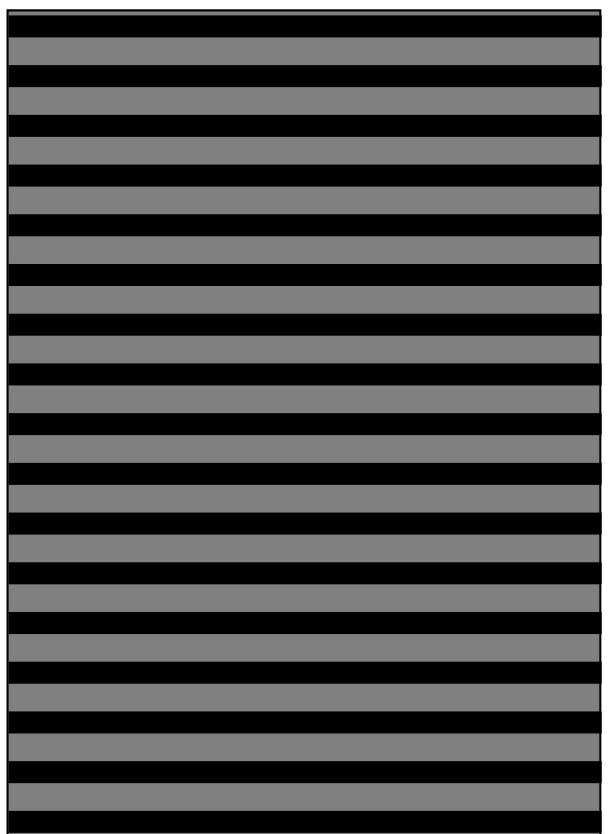

10

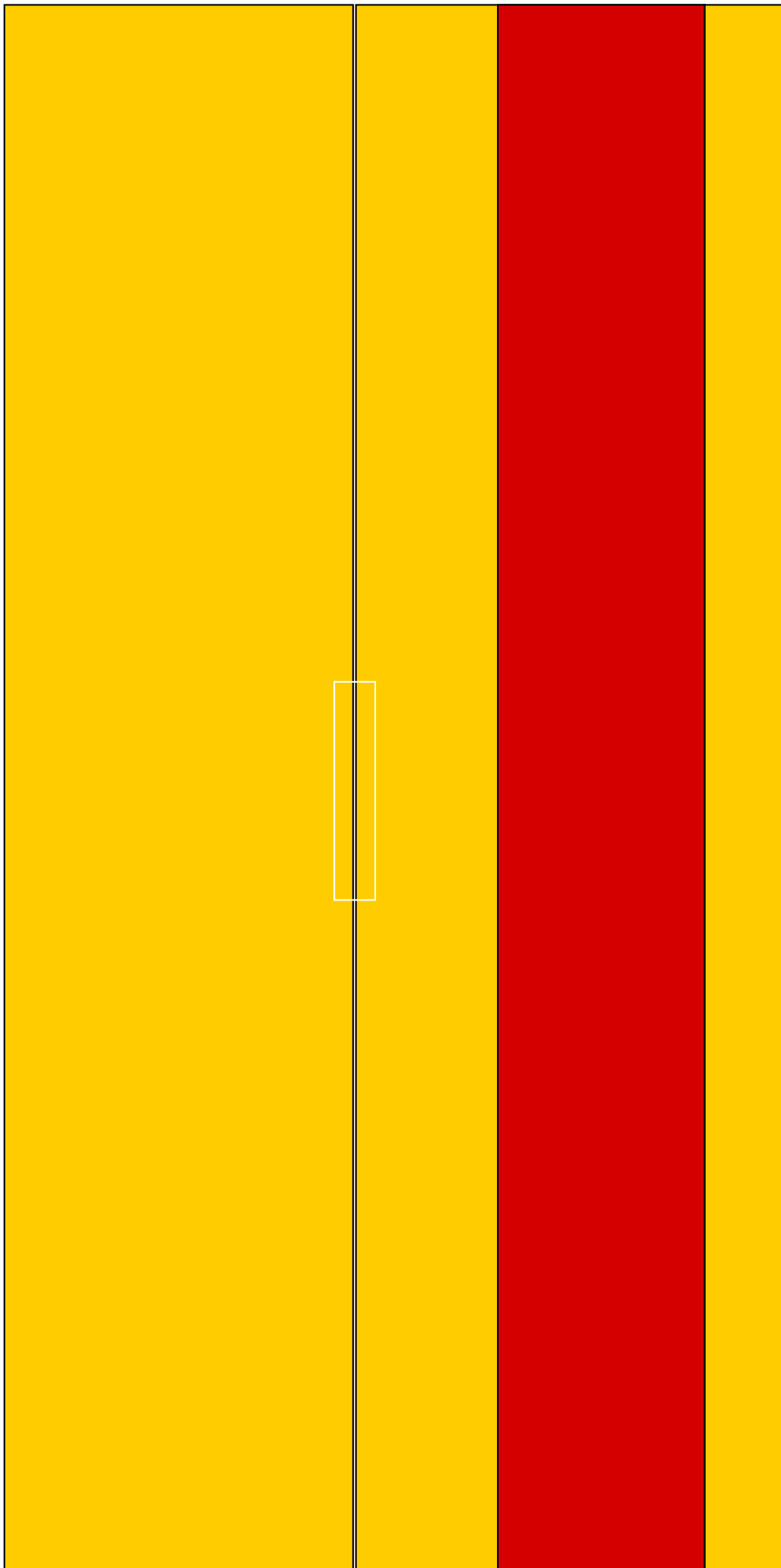

11

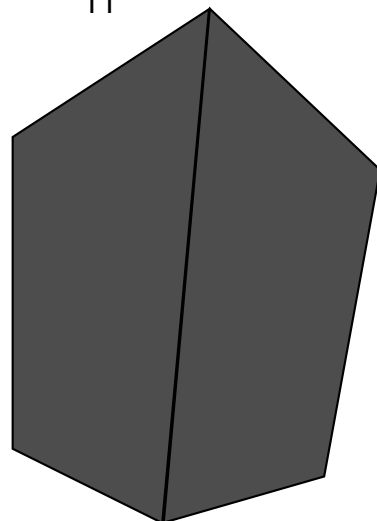

11

