

TECHNO ALPIN T 60

Diese Skizze soll dir eine kleine Hilfe beim zusammenbauen der ModellRopeways Techno Alpin T 60 sein.
Die Nummern in der Skizze entsprechen den Nummern der jeweiligen Bogenteile.

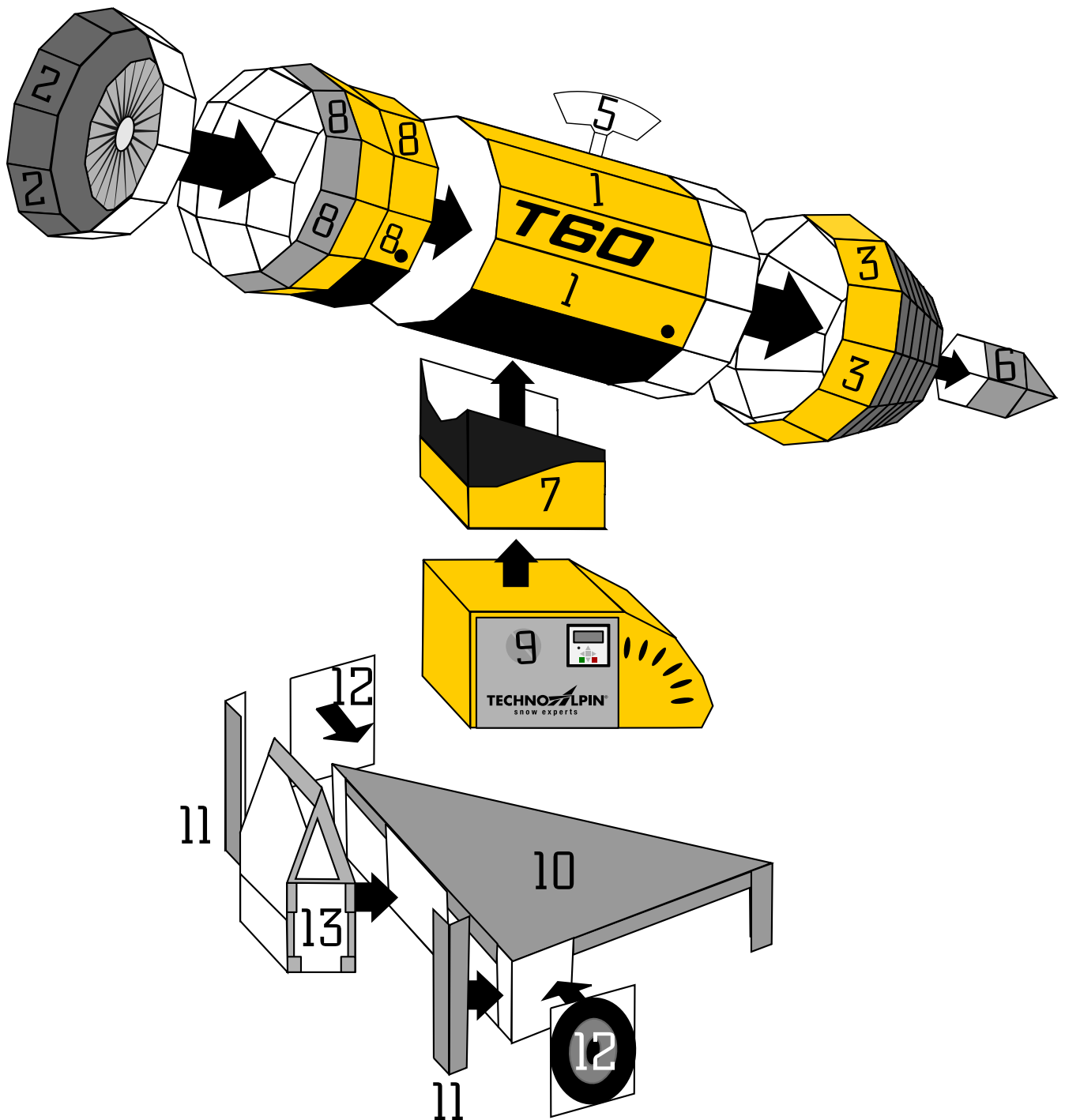

1

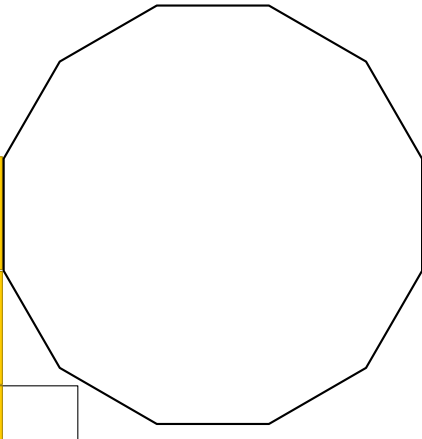
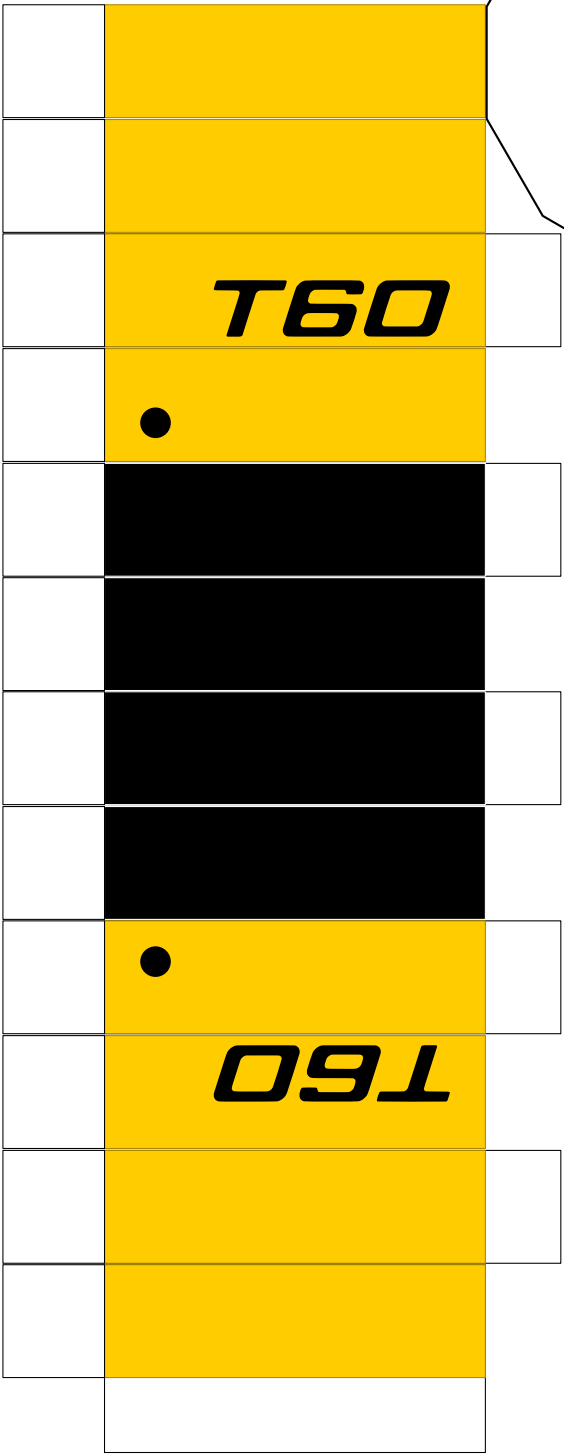

2

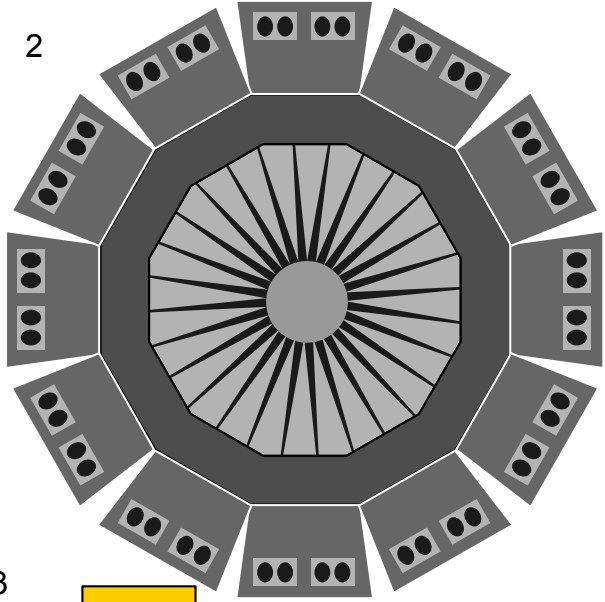

3

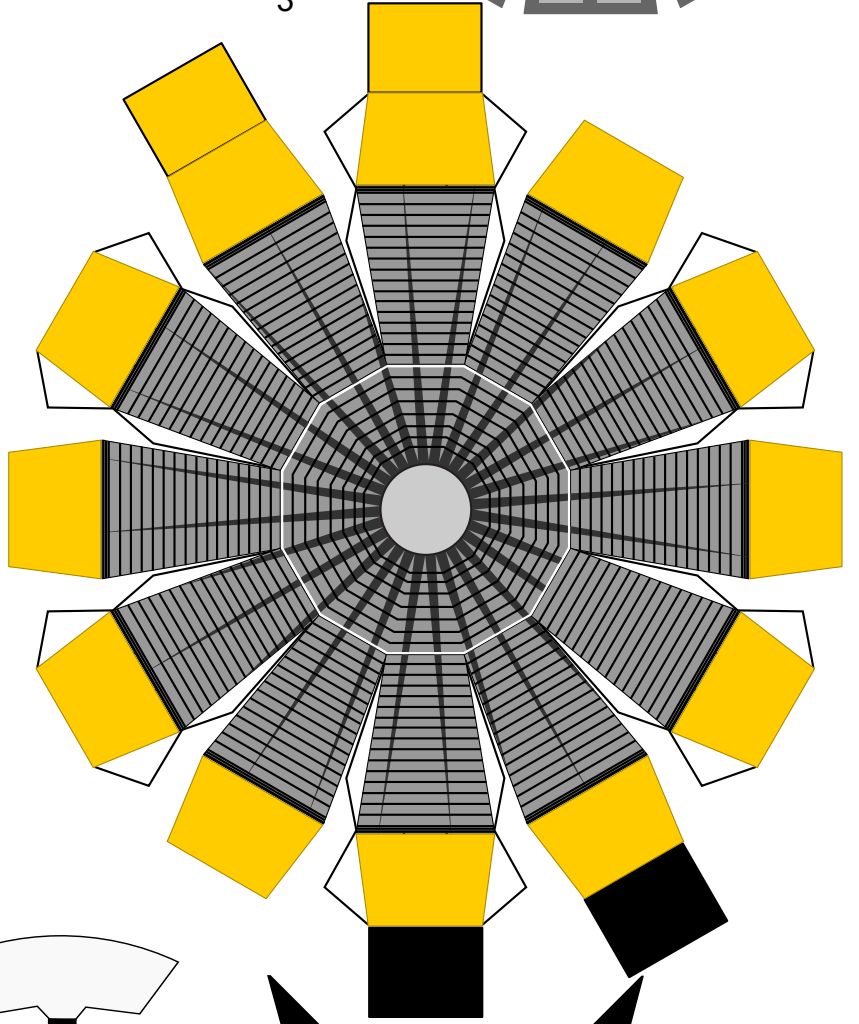

5

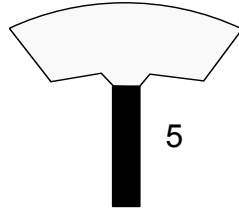

7

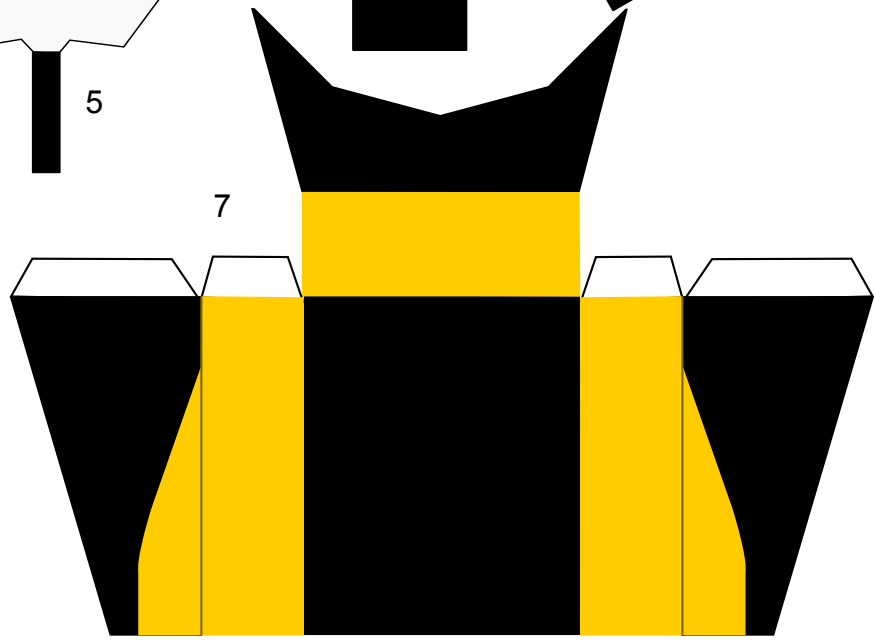

6

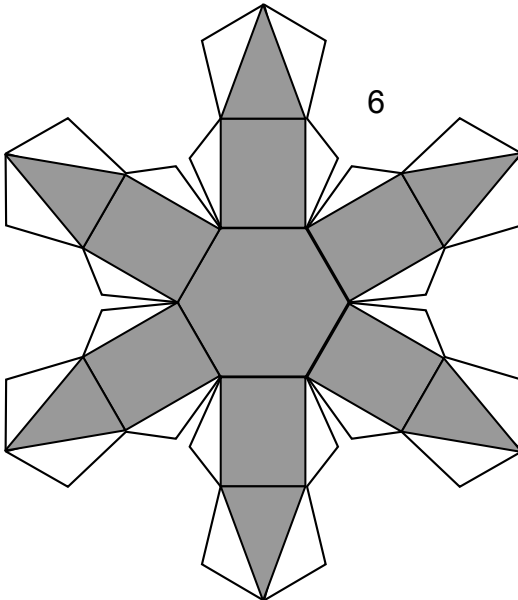

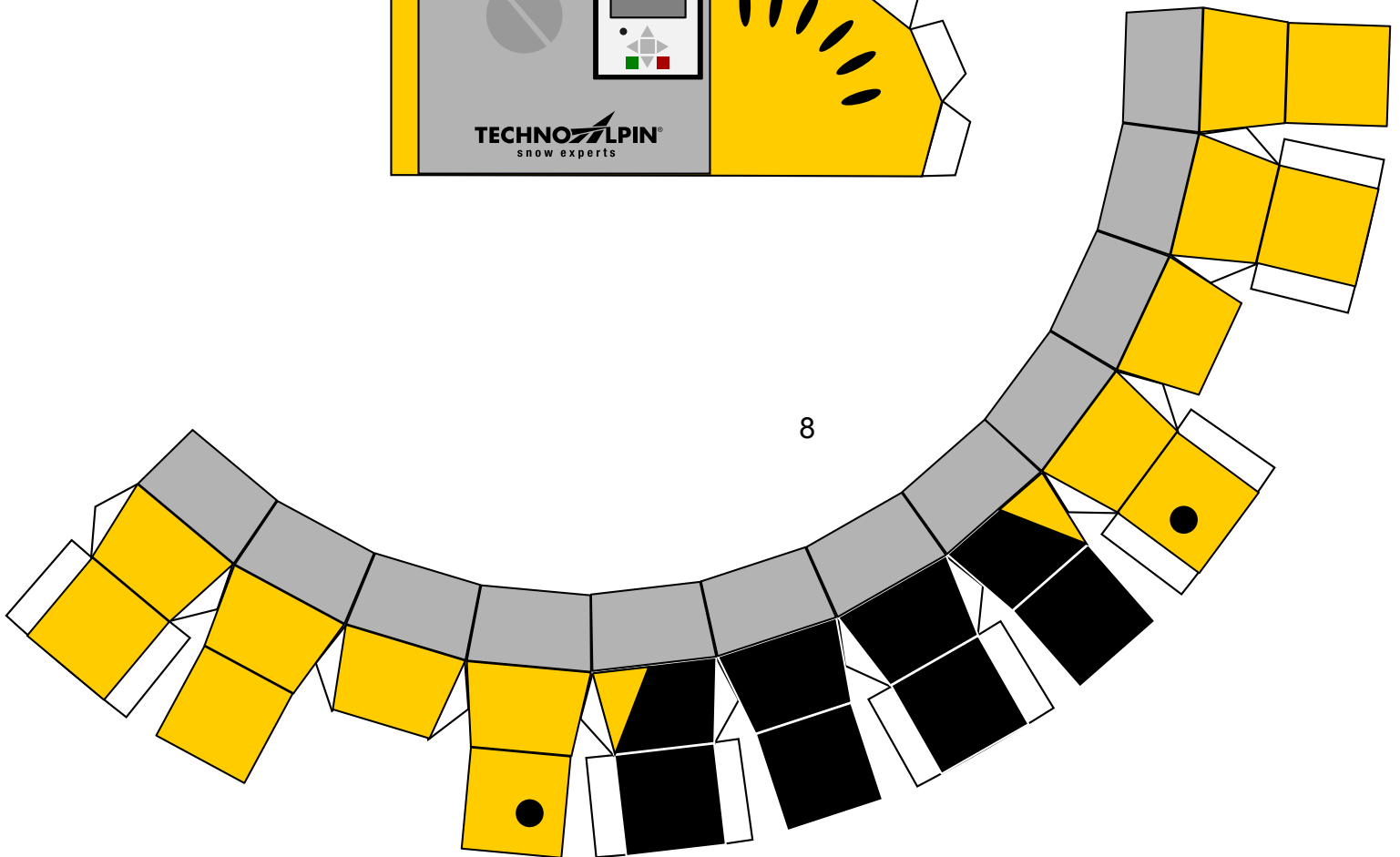
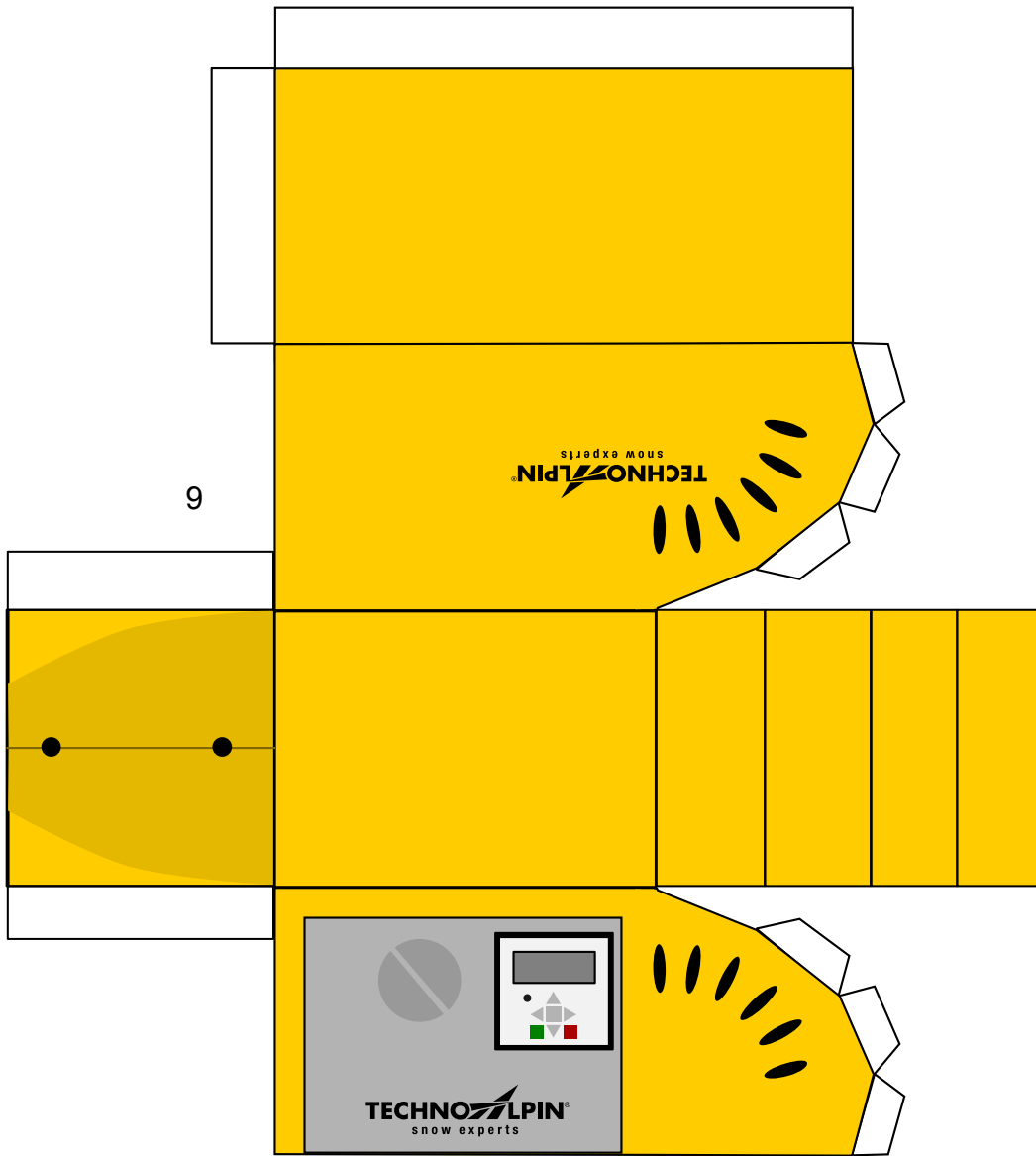

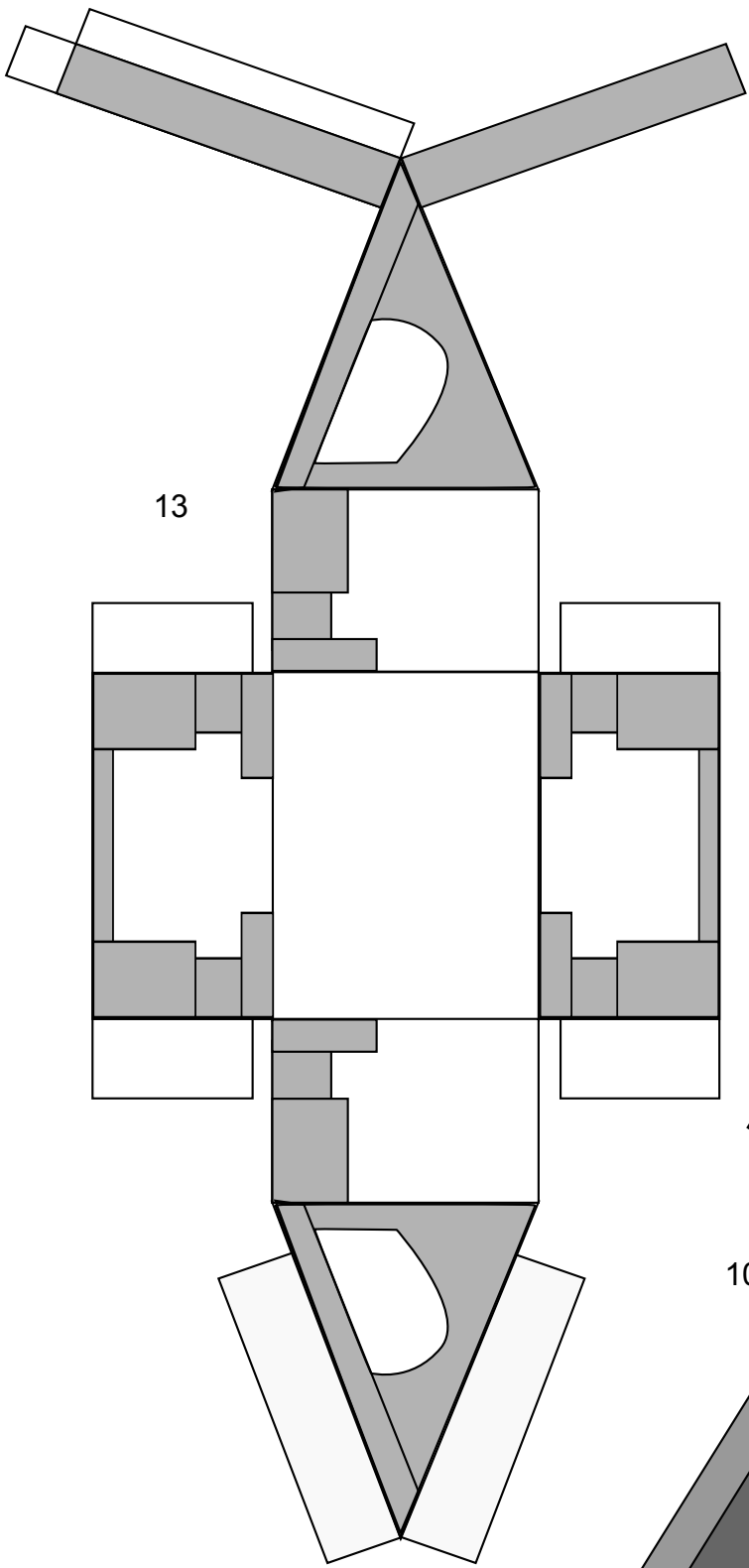

13

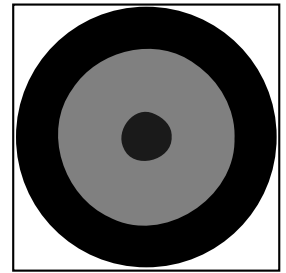

12

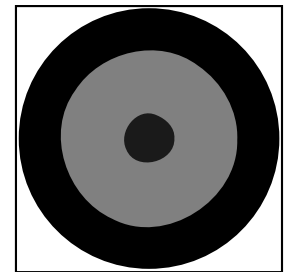

12

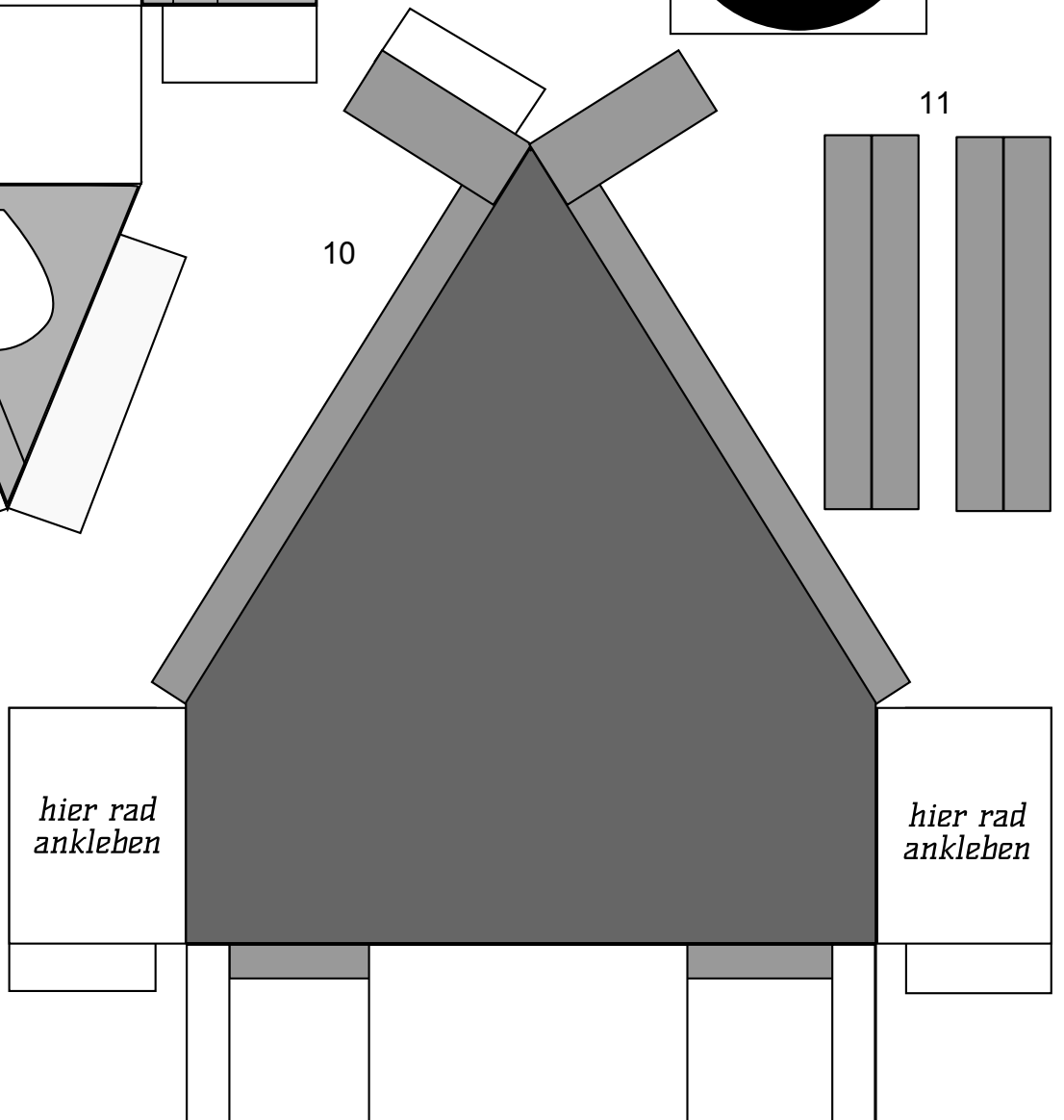

10

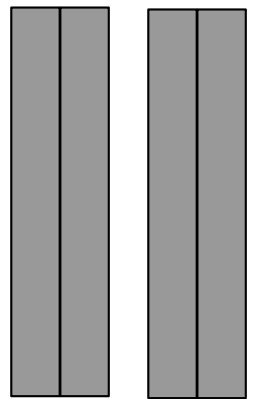

11

*hier rad
ankleben*

*hier rad
ankleben*