

TECHNO ALPIN T 40

Diese Skizze soll dir eine kleine Hilfe beim zusammenbauen der ModellRopeways Techno Alpin T 40 sein.
Die Nummern in der Skizze entsprechen den Nummern der jeweiligen Bogenteile.

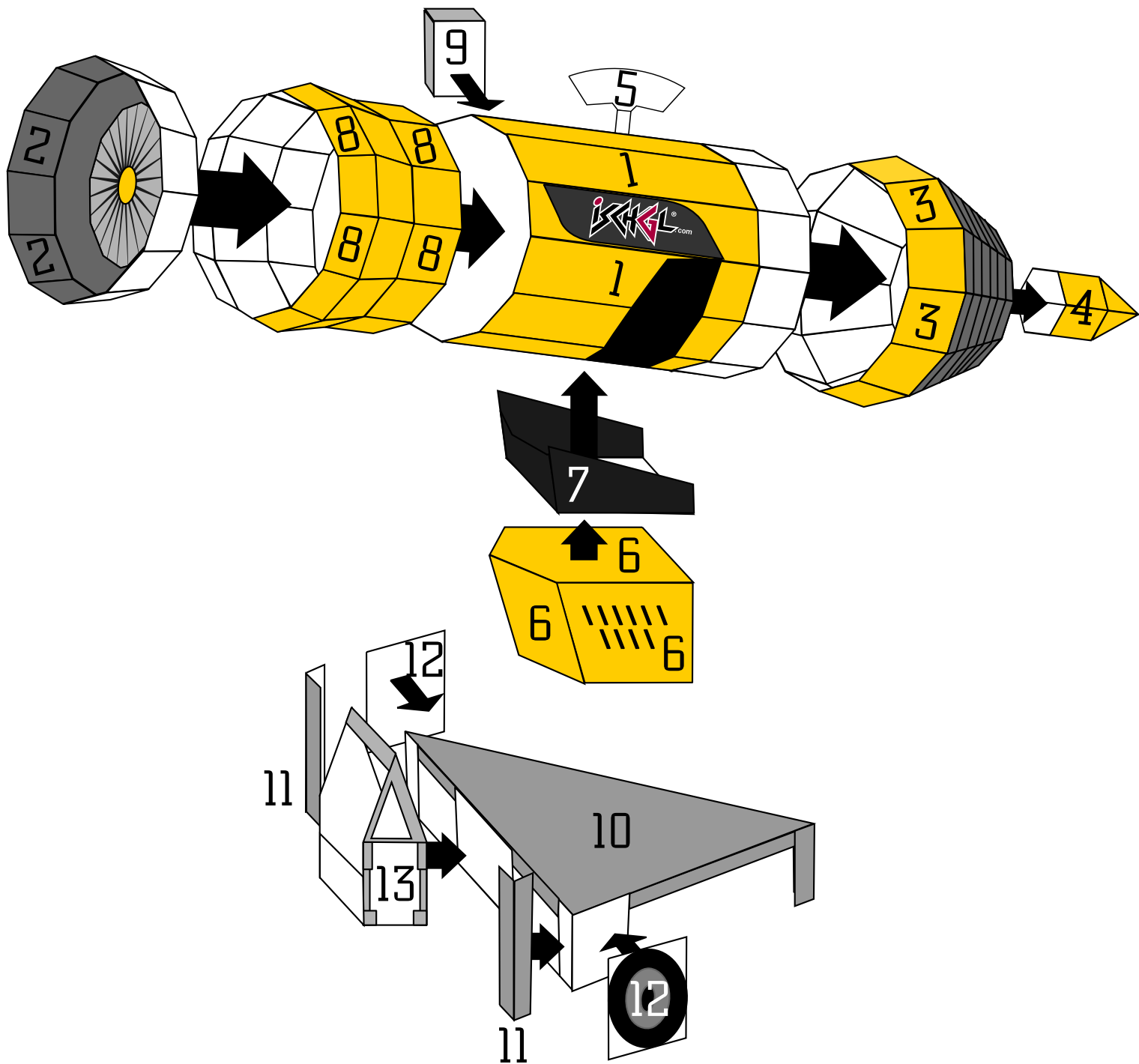

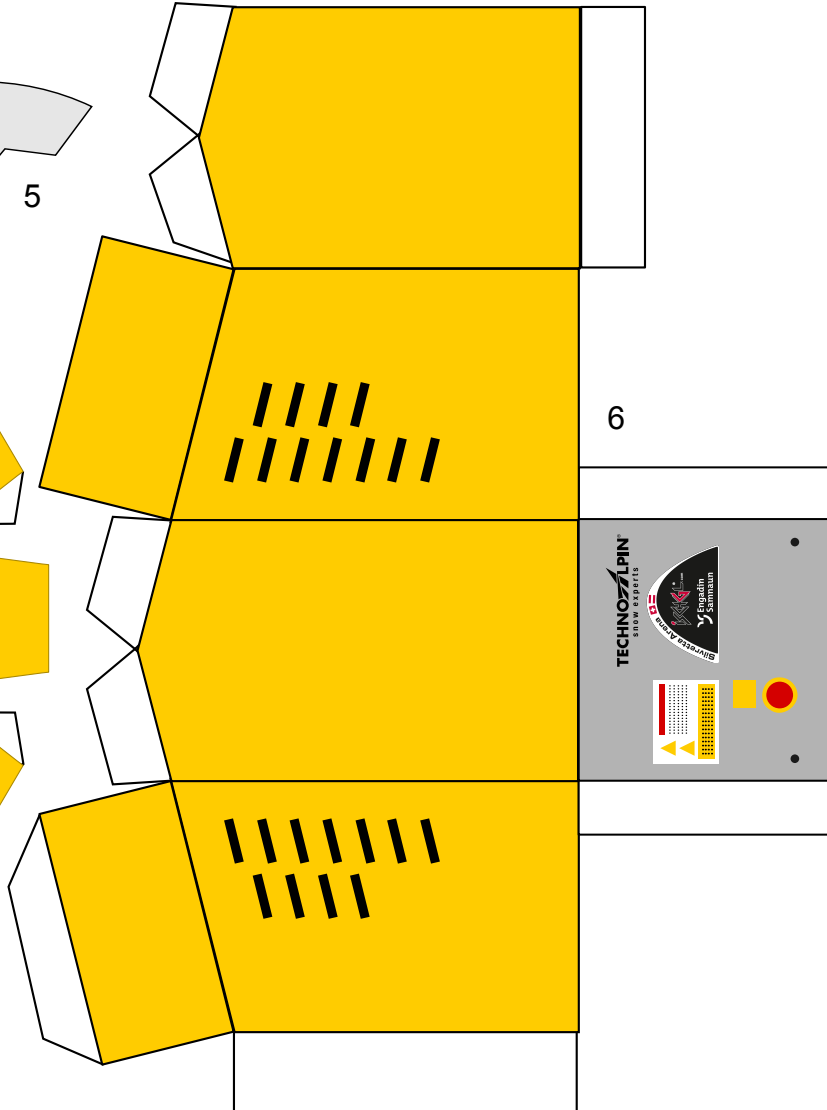

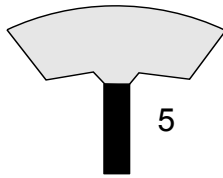
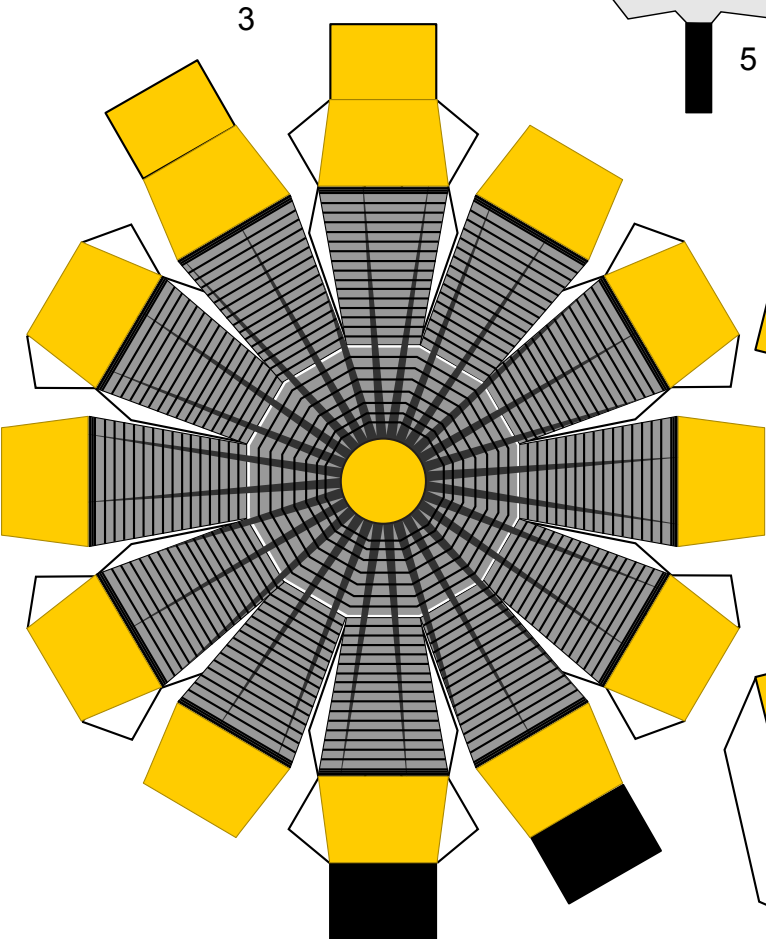
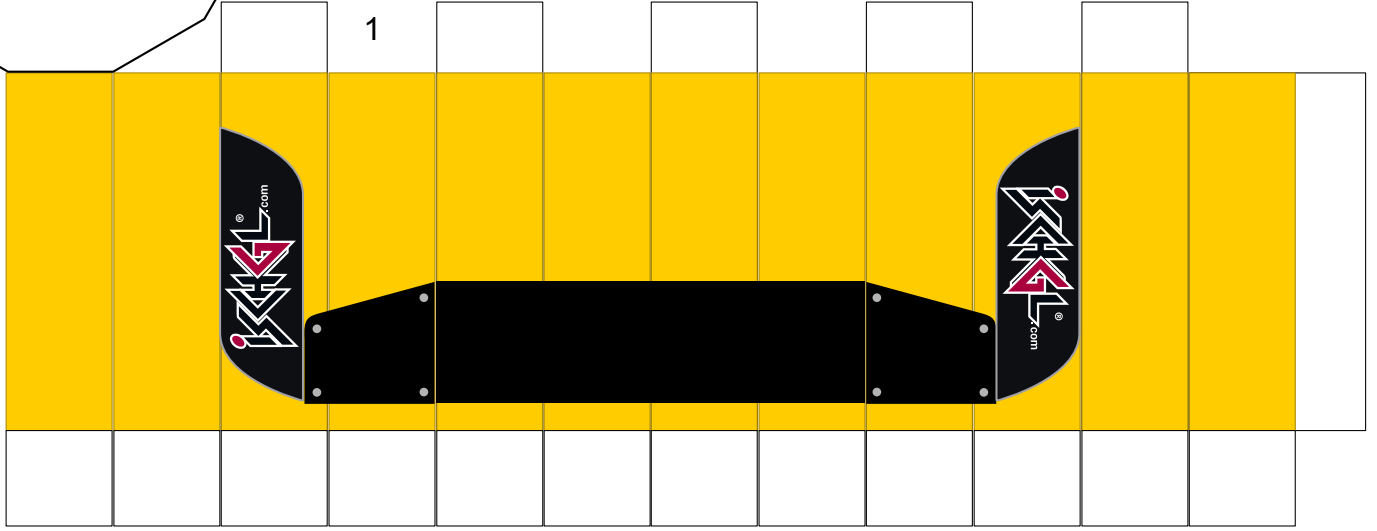
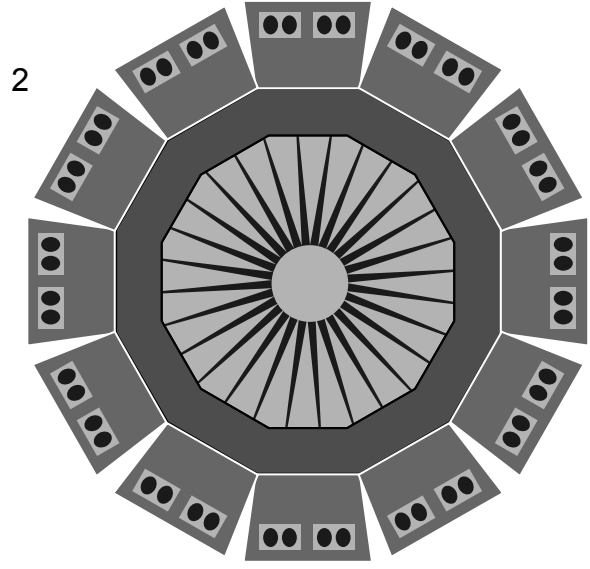
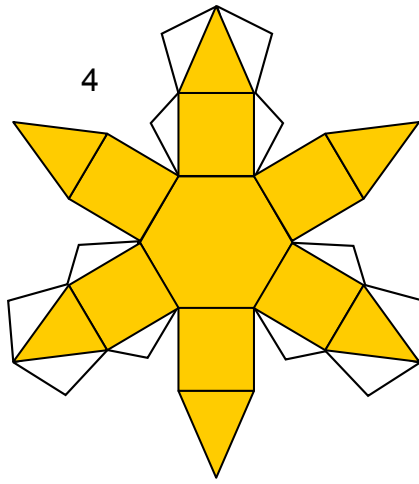
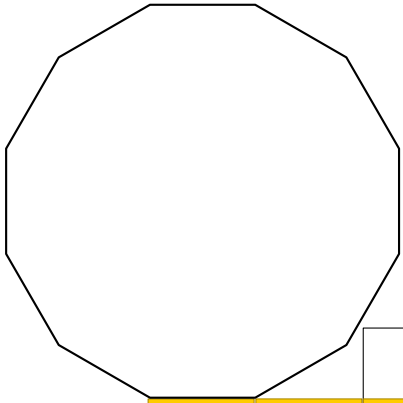
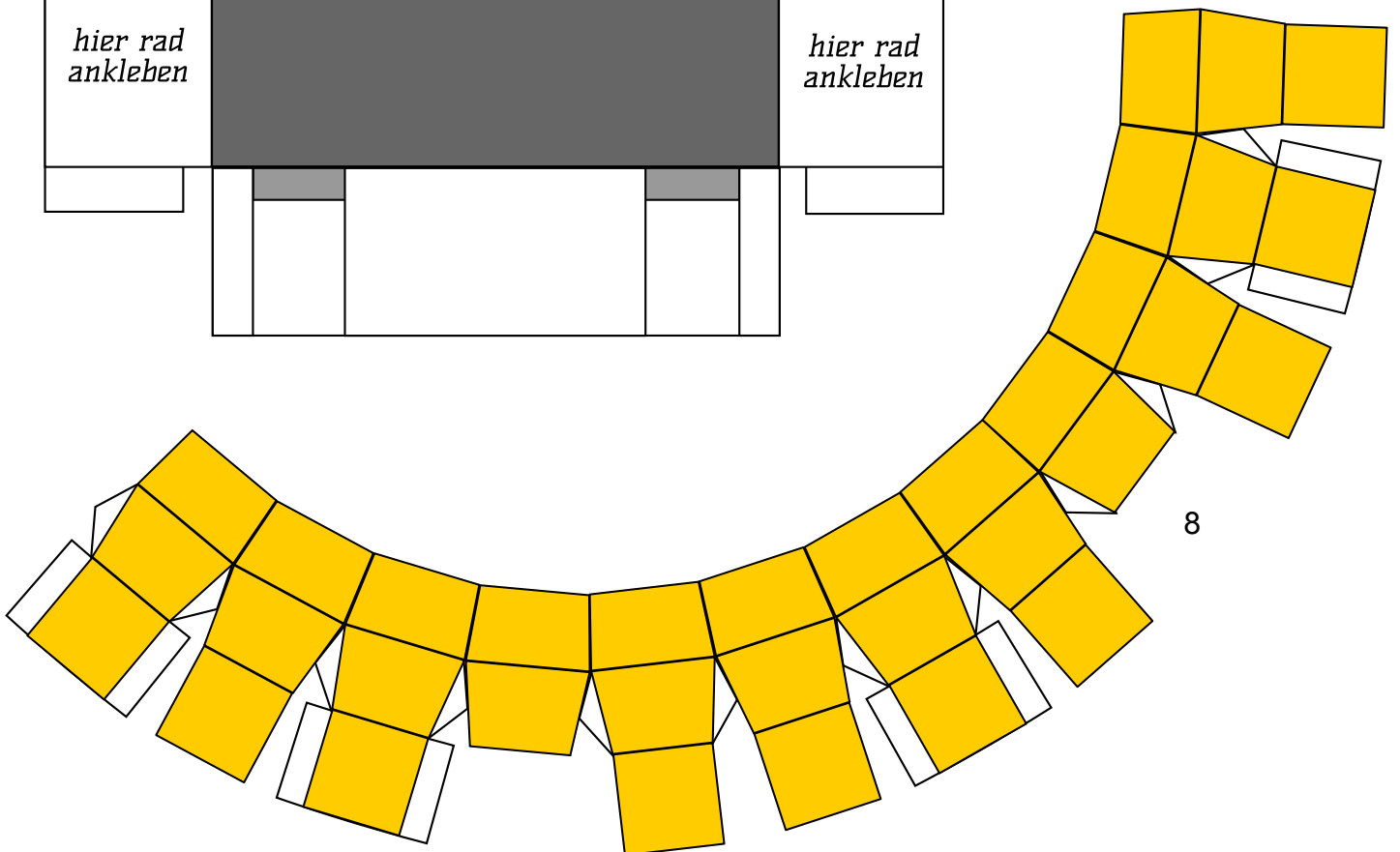
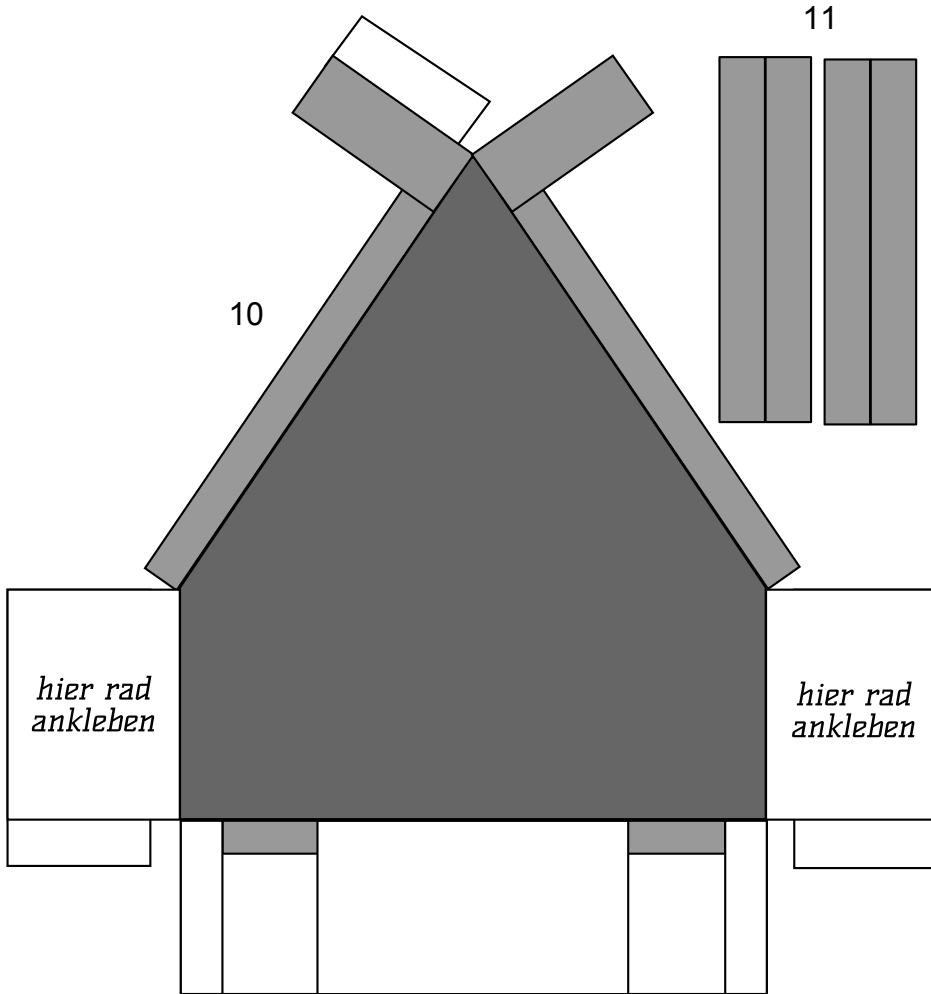
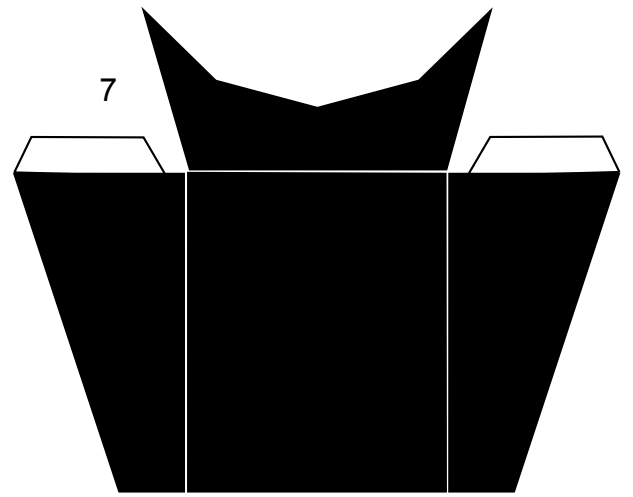
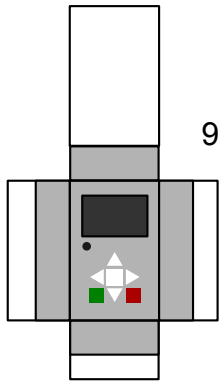

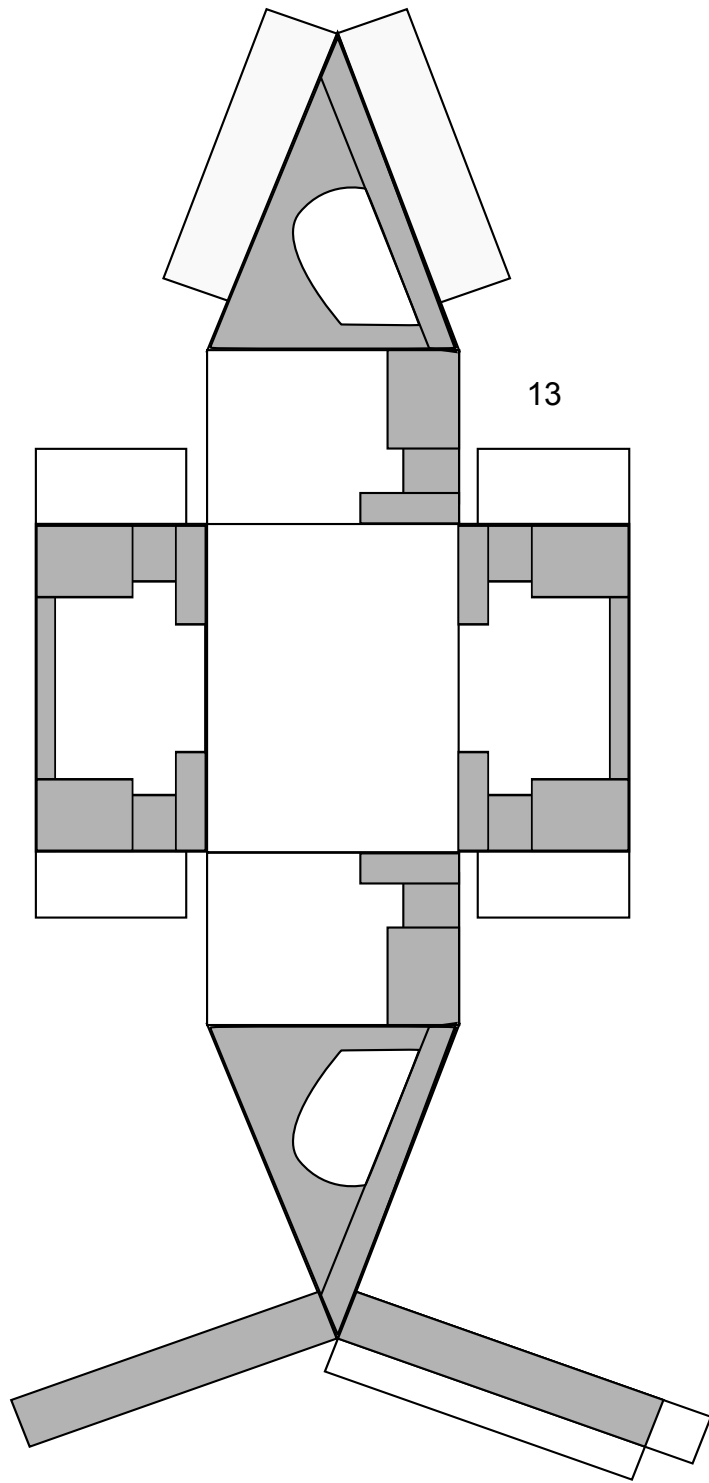

13