

# DEMACLENKO TITAN

Diese Skizze soll dir eine kleine Hilfe beim zusammenbauen der ModellRopeways DemacLenko Titan sein. Die Nummern in der Skizze entsprechen den Nummern der jeweiligen Bogenteile.

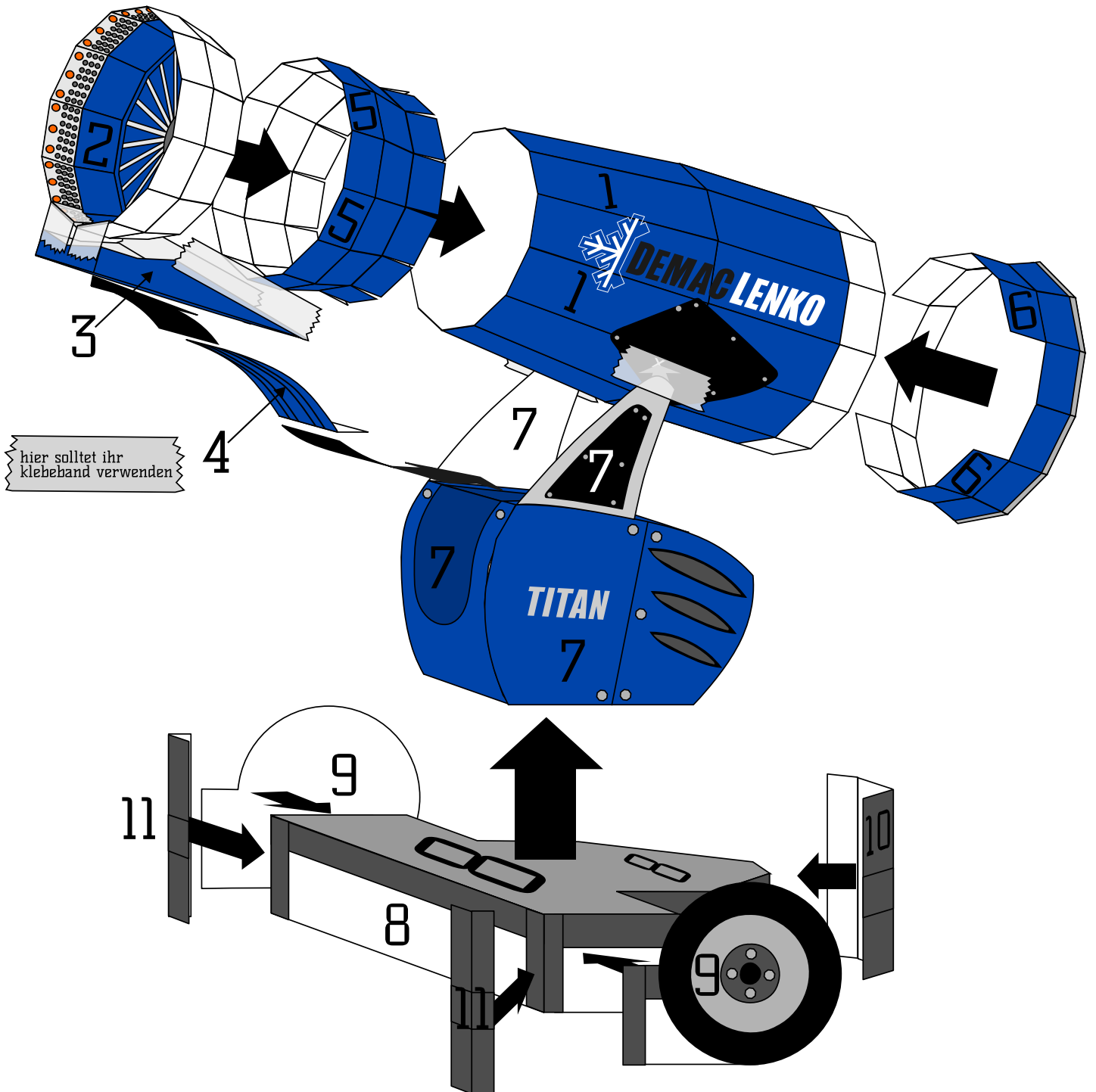

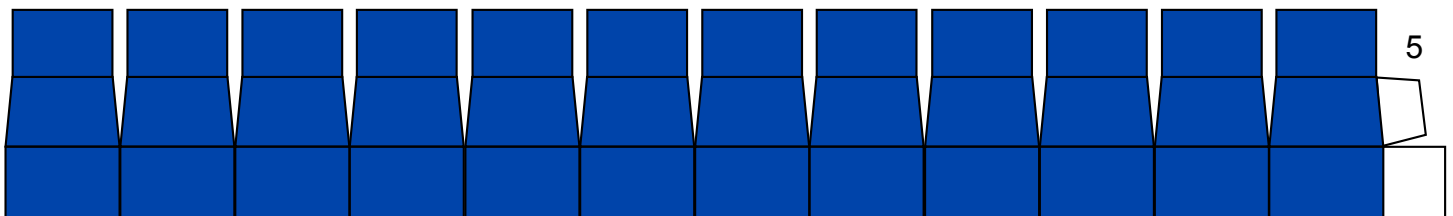

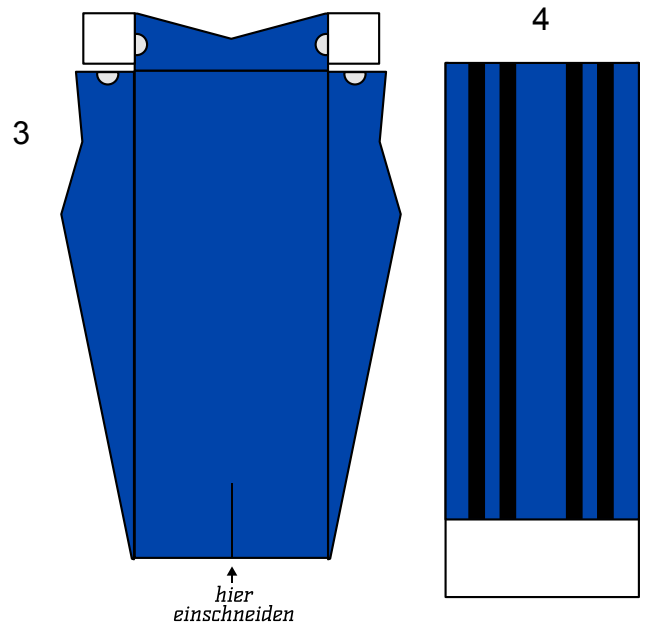
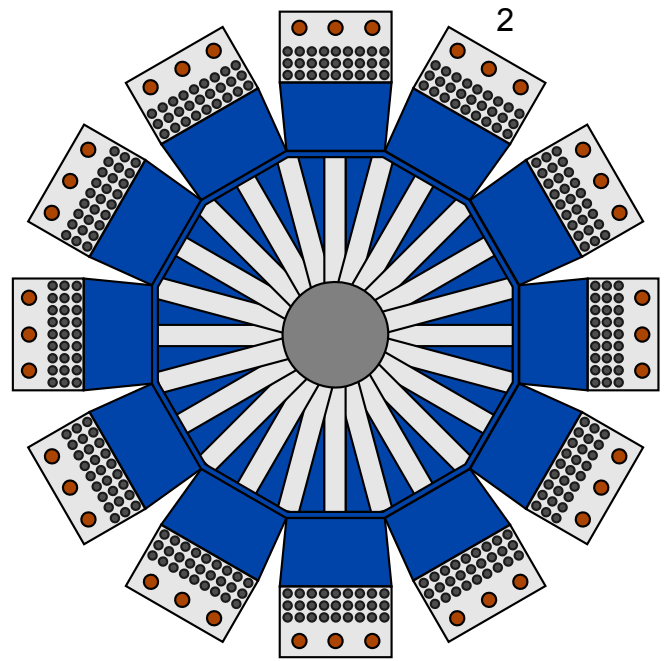
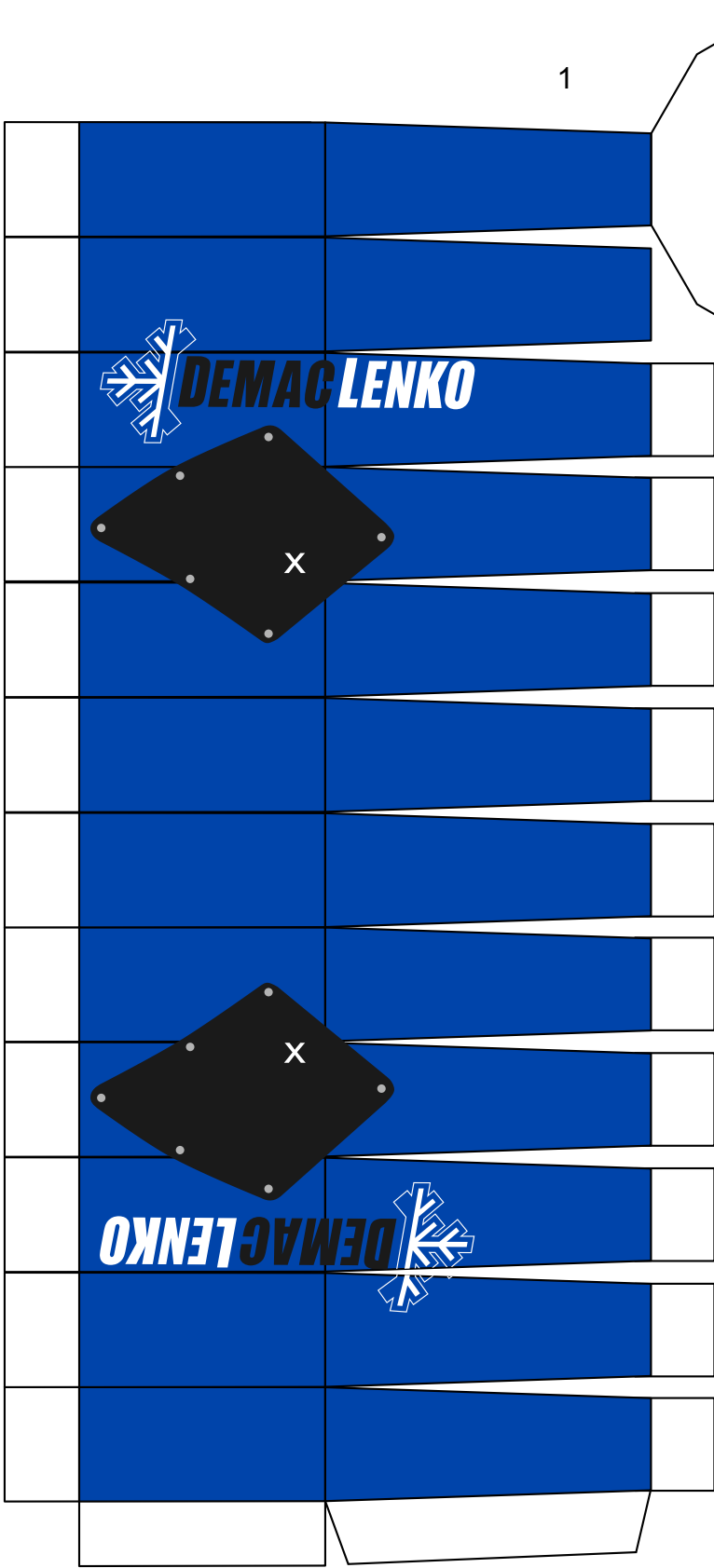
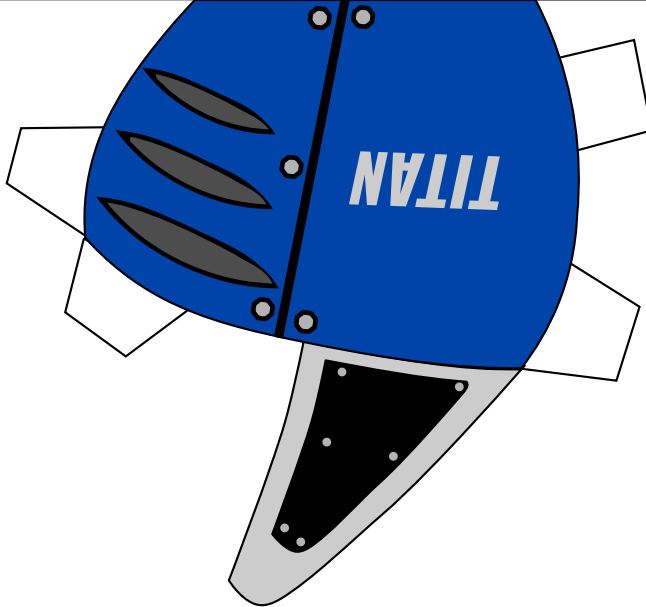
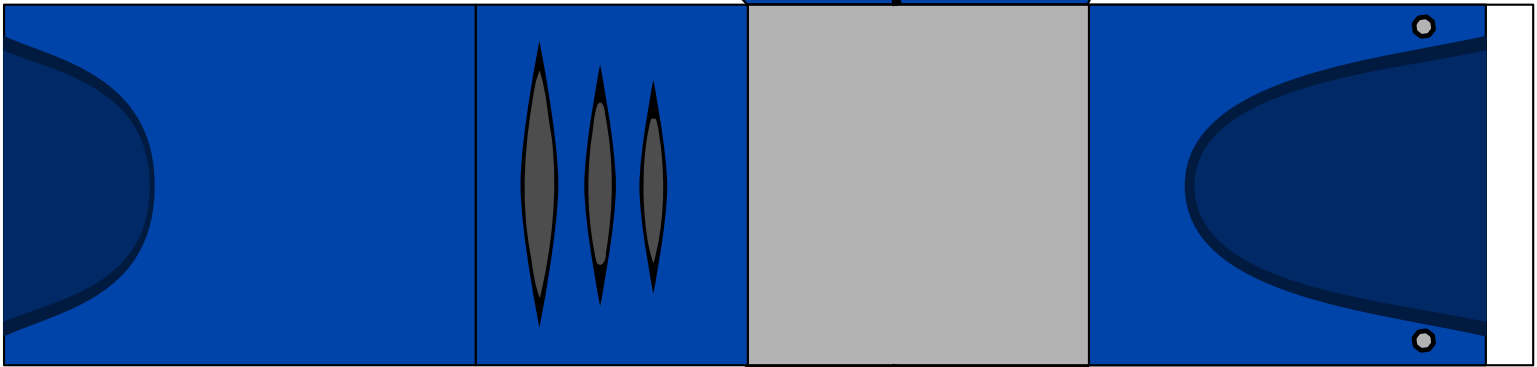
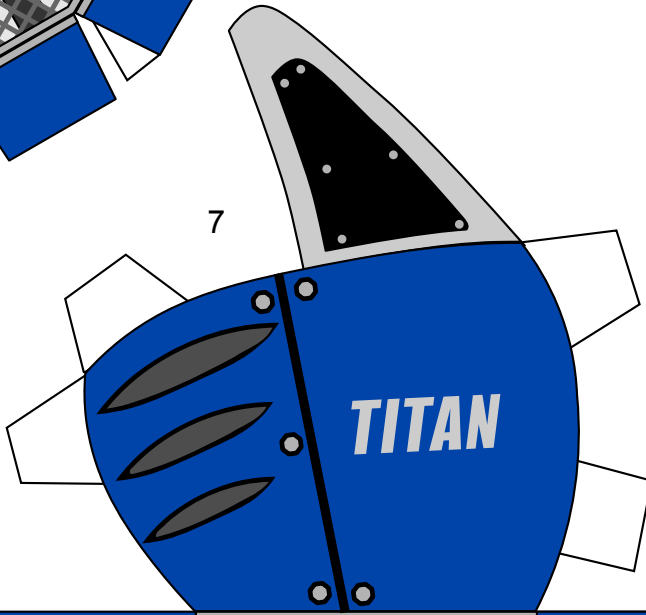
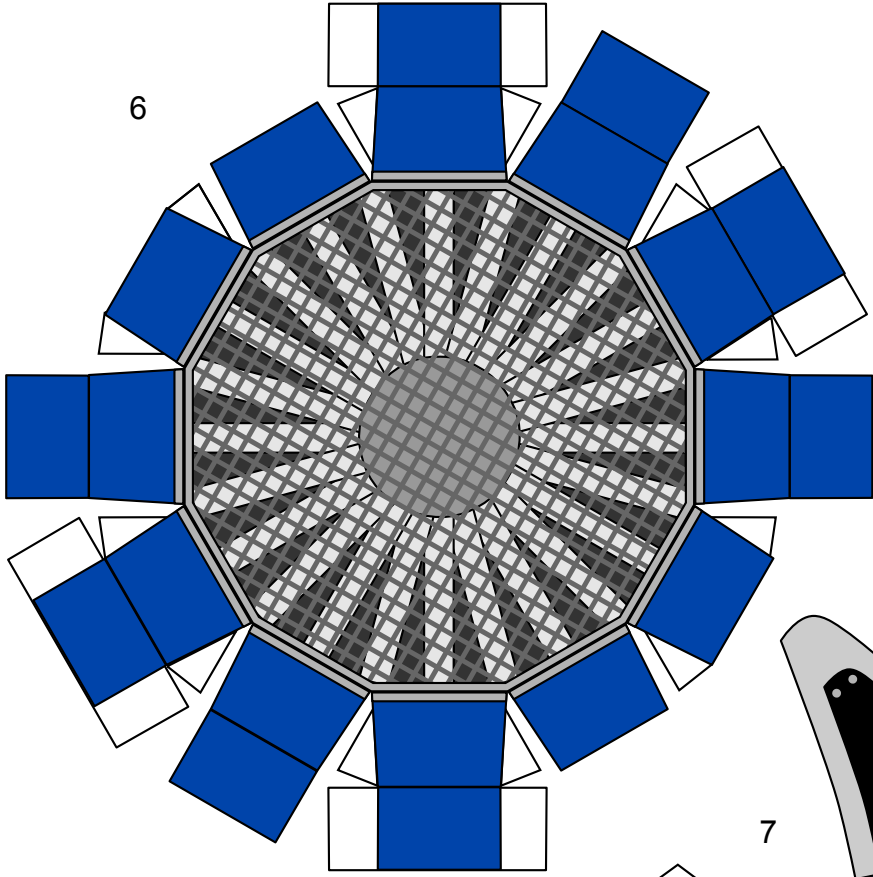

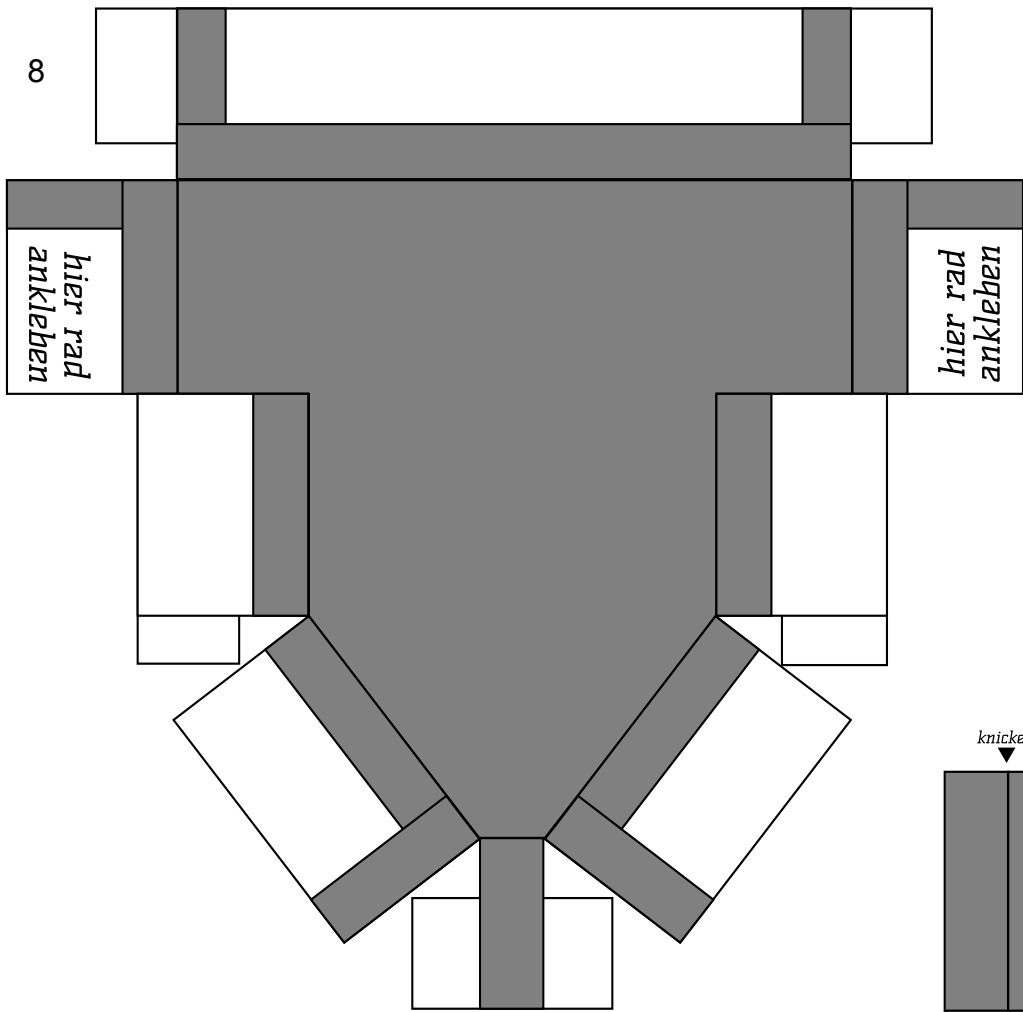

8

hier rad  
ankleben

hier rad  
ankleben

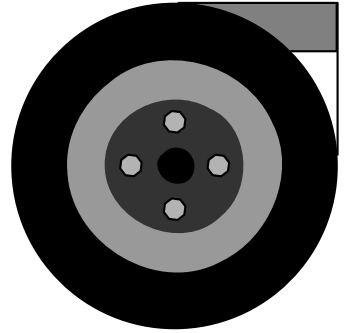

9

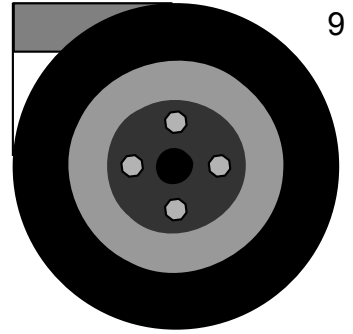

9

knicken knicken

knicken

knicken

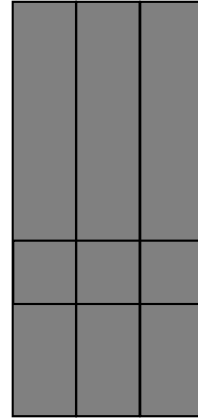

10

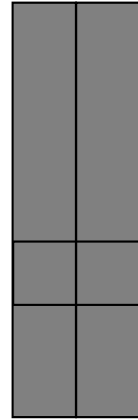

11

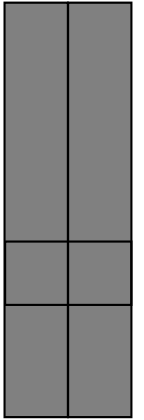

11